

EscAlphiMDS

SAFETY



SAFETY

| PRODUCTIVITY

| SIMPLICITY

| QUALITY

WORKSITE SPIRAL
STAIRCASE WITH
SIDE EXIT

EscAlphi MDS | Worksite spiral staircase with side exit



EscAlphiMDS

EscAlphi MDS (safe assembly and disassembly) is a metal spiral staircase with **side exit**. The triangular step then acts as a landing.

Simply arrange EscAlphi MDS by rotating by a quarter-turn so that one of the steps is aligned with the slab to be served. It is formed from a base, 1 to 8 modules that are easy to stack with a crane and a head guardrail closing the passage (max height 20.10 m).

Set-up under collective protection (harness-free) is quick and easy: 4 nuts per module. Each module is equipped with collapsible guardrails, hinged about a non-detachable end.

EscAlphi MDS can be moved using a crane.

Its small footprint facilitates its installation, even on small sites.



*Site in Switzerland
Client: Induni
Location: Geneva*

EscAlphi MDS | Worksite spiral staircase with side exit

SAFETY

Easy, secure access

All levels are accessible without adaptation.

Assembly and disassembly with collective protection

The guardrails are built-in (harness-free).

PRODUCTIVITY

- Quick installation and movement.
- Compact footprint.
- Only 3 different single-block elements.
- Can be handled with a crane.
- Compatible with 2- and 3-rail EscAlphi MDS.



QUALITY

Robust and galvanized

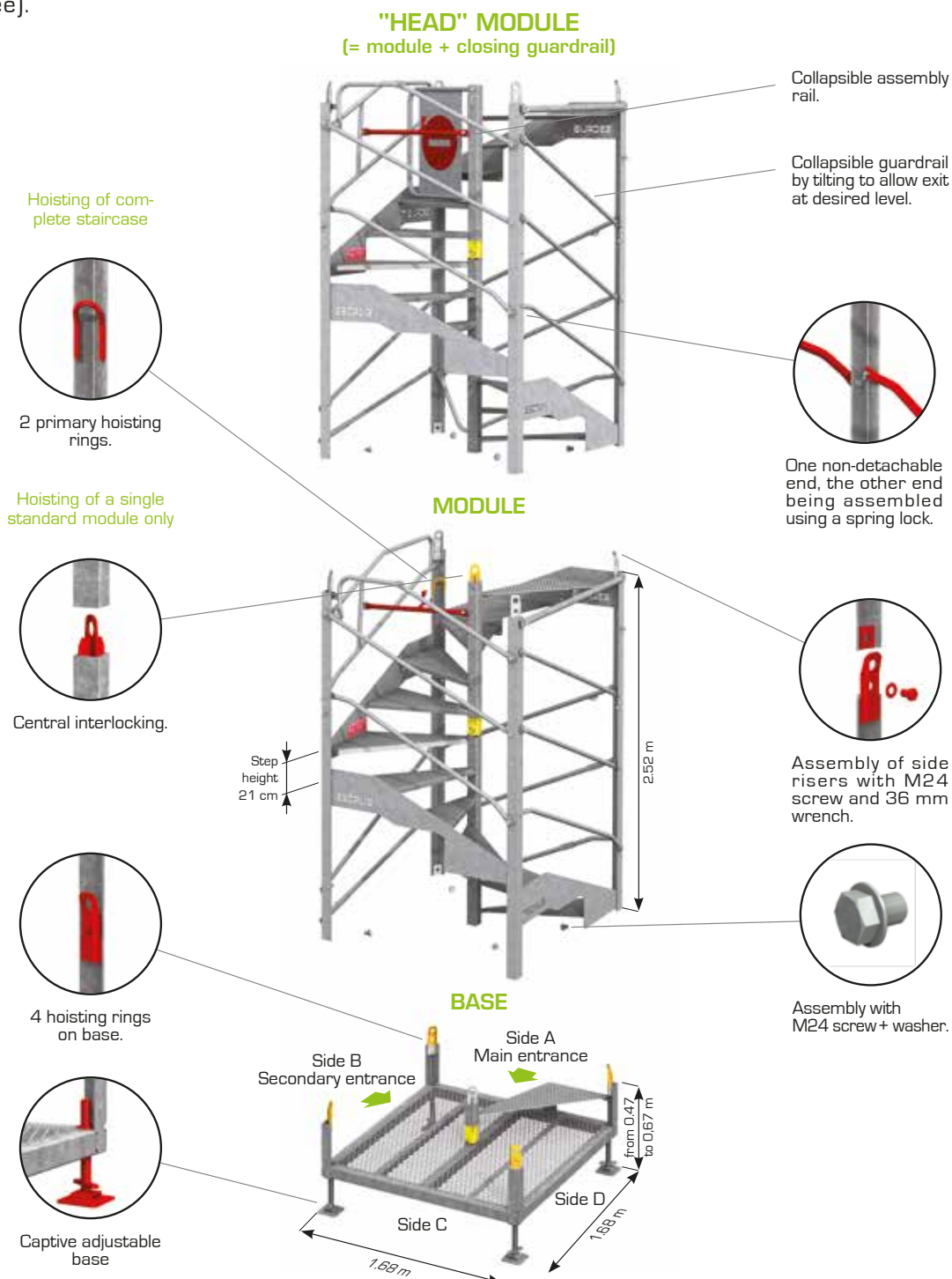
- Powder-coated paint version available.



COMPONENTS

| Head module | Module | Weight (kg) | Catalogue Number |
|---|--|-------------|------------------|
| |  | 380 | 013252-2 |
| | Closing guardrail | Weight (kg) | Catalogue Number |
| |  | 15 | 013119-3 |
| Assembled module | Weight (kg) | | |
|  | 395 | | |

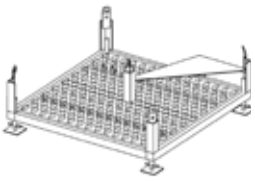
| Base | Base | Weight (kg) | Catalogue Number |
|------|---|-------------|------------------|
| |  | 184 | 013045-0 |

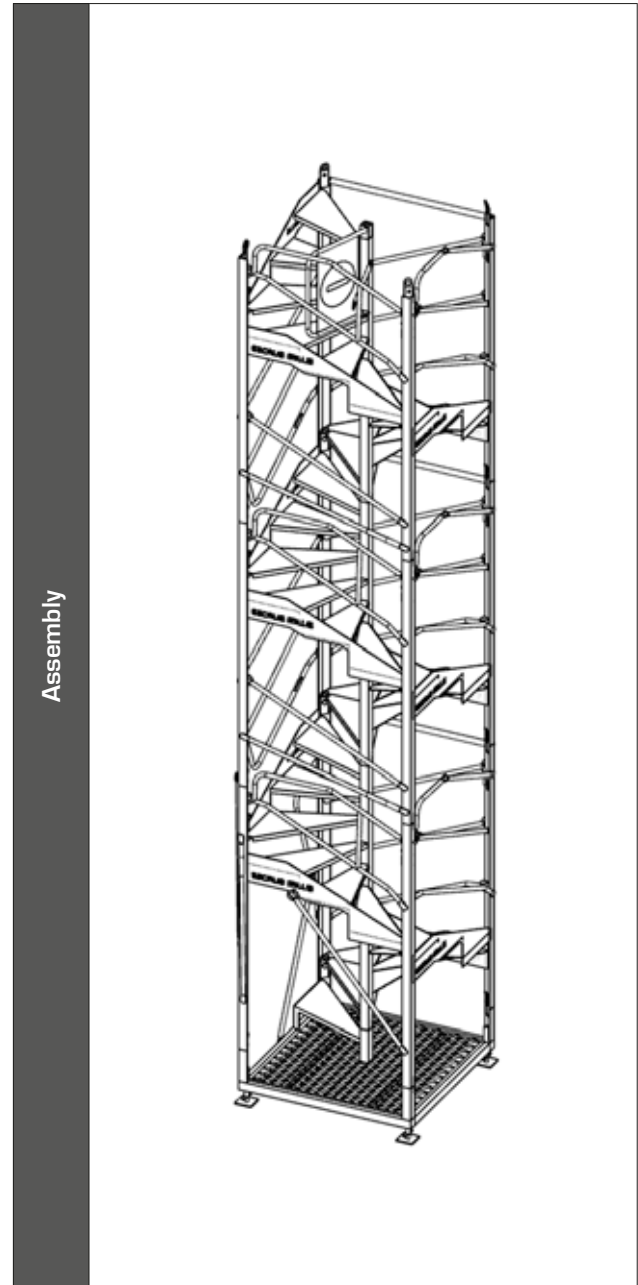





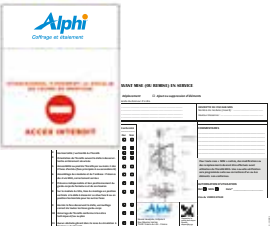











ESCALPHI MDS ACCESSORIES

| | | | | |
|---|---|------------------|---|---|
| Tethering and anchoring equipment | Collar | Weight (kg) | Catalogue Number | Description |
| |  | 2.0 | 013049-2 | <ul style="list-style-type: none"> Slip resistance: 515 daN SLS Positioned along module risers |
| | Tethering half-collar | Weight (kg) | Catalogue Number | Description |
| |  | 0.66 | 018570-2 | <ul style="list-style-type: none"> Slip resistance: 515 daN SLS Mounted on the holes situated 1.50 m from the bottom of the modules |
| | Petzl ring | Weight (kg) | Description | |
| |  | 0.06 | <ul style="list-style-type: none"> Use to secure the tower clamp onto a skin | |
| | Tower clamp | Weight (kg) | Description | |
| |  | 3.50 | <ul style="list-style-type: none"> Used to secure the tower to a skin Has a safety hook | |
| Complete tethering rail | Weight (kg) | Catalogue Number | Description | |
|  | 1.80 | 023031-8 | <ul style="list-style-type: none"> Pin + eye bolt + 1/2 rail | |
| | 4.00 | 023032-6 | | |

| | | | |
|------------|---|-------------|------------------|
| Additional | Plastic folder for verification report | Weight (kg) | Catalogue Number |
| |  | 0.30 | NCO410 NCO411 |

SPARE PARTS FOR MAINTENANCE

| Rails | Straight rail | Weight (kg) | Catalogue Number |
|---|---|------------------|------------------|
| |  | 3.3 | 013502-0 |
| | Curved rail | Weight (kg) | Catalogue Number |
| |  | 3.4 | 013503-8 |
| | Clamping plate rail side A | Weight (kg) | Catalogue Number |
| |  | 3.4 | 013504-6 |
| | MDS flattened straight rail side A | Weight (kg) | Catalogue Number |
| |  | 3.3 | 013510-3 |
| | MDS flattened curved rail side A | Weight (kg) | Catalogue Number |
| |  | 3.6 | 013511-1 |
| | MDS guardrail with lock side B | Weight (kg) | Catalogue Number |
| |  | 7.5 | 013512-9 |
| | MDS sliding rail side B | Weight (kg) | Catalogue Number |
| |  | 3.6 | 013513-7 |
| | MDS hinged rail side C | Weight (kg) | Catalogue Number |
|  | 4.1 | 013514-5 | |
| MDS rail with lock side C | Weight (kg) | Catalogue Number | |
|  | 3.4 | 013515-2 | |
| MDS assembly rail | Weight (kg) | Catalogue Number | |
|  | 1.8 | 013516-0 | |

| Module assembly | H-M24x35-8-8 screw + washer | Weight (kg) | Catalogue Number |
|---|---|------------------|------------------|
| |  | 0.27 | NC0400 |
| Lock-end rail assembly | Threaded clamping plate + pin | Weight (kg) | Catalogue Number |
| |  | 0.15 | NC0401 |
| Lock-end rail assembly | Complete M14 spring lock | Weight (kg) | Catalogue Number |
| |  | 0.09 | NC0405 |
| Bolt-end rail assembly | Complete M16 bolt | Weight (kg) | Catalogue Number |
| | Pin | 0.14 | NC0406 |
| | Rivet | | |
| Base jacks |  | | |
| | or | | |
| |  | | |
| | Complete jack with rivets | Weight (kg) | Catalogue Number |
|  | 4.6 | 013508-7 | |
| Bolt- and caulking-free jack | Weight (kg) | Catalogue Number | |
|  | 4.0 | 013509-5 | |

CONFIGURATIONS

EscAlphi MDS consists of 3 different single-block elements.

| Description | Catalogue Number | Weight (kg) | Composition Number of modules | | | | | | | |
|---------------------------|------------------|-------------|-------------------------------|-----|-------|-------|-------|-------|-------|-------|
| | | | 1 | 2 | 3 | 4 | 5 | 6 | 7 | 8 |
| Module | 013252-2 | 380 | 1 | 2 | 3 | 4 | 5 | 6 | 7 | 8 |
| Closing guardrail | 013119-3 | 15 | 1 | 1 | 1 | 1 | 1 | 1 | 1 | 1 |
| Base | 013045-0 | 184 | 1 | 1 | 1 | 1 | 1 | 1 | 1 | 1 |
| Total weight (kg) | | | 579 | 959 | 1,339 | 1,719 | 2,099 | 2,479 | 2,859 | 3,239 |
| Maximum height served (m) | | | 2.5 | 5.0 | 7.5 | 10.0 | 12.6 | 15.1 | 17.6 | 20.1 |

Up to 8 stacked modules

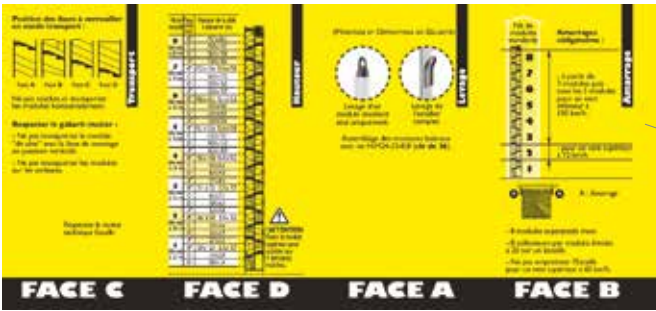

An information label is stuck onto the modules and bases to define the orientation of EscAlphi MDS according to the height to be served and repeat the assembly, hoisting, tethering and transport instructions.

Module



- All the sides of the module are secured by guardrails.
CAUTION: Maximum height served \approx number of modules x 2.50 m.

- Exit configurations at the level of the slab to be served.

"Head" module: closing guardrail + module



- The closing guardrail can be mounted on the module prior to delivery on-site.

Module on base: main entrance configuration (side A)



CONFIGURATION

Module on base: secondary entrance configuration (side B)



USER GUIDE: HEIGHT COMPOSITION

HEIGHT COMPOSITION

- Not more than 8 stacked modules. Above this value, please contact our design office.
- 8 users per module, limited to 20 on EscAlpha MDS.
- Make sure that the ground level intended to receive the EscAlpha MDS is capable of withstanding the loads.
- Tethering mandatory for winds above 72 km/h.
- Tethering mandatory from 3 modules, then every 3 modules for winds below 150 km/h

For an EscAlpha MDS with 2 modules

The last 4 steps are accessible with the third module. With 2 modules, the height served is limited to 5 metres.

| No. of modules | Wall end face | Height of slab to be served (m) |
|--------------------------------|---------------|---------------------------------|
| 2 max. slab of 5.0 m | A* | 5.2 to 5.8 |
| | B* | 4.6 to 5.0 5.0 to 5.2 |
| | C | 3.9 to 4.6 |
| | D | 3.3 to 3.9 |
| 1 max. slab of 2.5 m | A* | 2.7 to 3.3 |
| | B* | 2.0 to 2.5 2.5 to 2.7 |
| | C | 1.4 to 2.0 |
| | D | 0.8 to 1.4 |

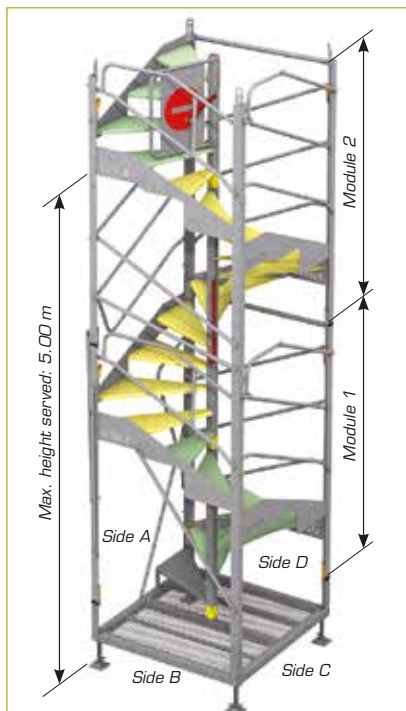

| No. of modules | Total weight (kg) | Wall end face | Height of slab to be served (m) | Height |
|---------------------------------|-------------------|---------------|------------------------------------|--------|
| 8 max. slab of 20.1 m | 3,239 | B* | 19.7 to 20.1 | 20 m |
| | | C | 19.0 to 19.7 | 19 m |
| | | D | 18.4 to 19.0 | 18 m |
| | | A* | 17.8 to 18.4 | 17 m |
| 7 max. slab of 17.6 m | 2,859 | B* | 17.2 to 17.6 17.6 to 17.8 | 17 m |
| | | C | 16.5 to 17.2 | 16 m |
| | | D | 15.9 to 16.5 | 15 m |
| | | A* | 15.3 to 15.9 | 14 m |
| 6 max. slab of 15.1 m | 2,479 | B* | 14.6 to 15.1 15.1 to 15.3 | 14 m |
| | | C | 14.0 to 14.6 | 13 m |
| | | D | 13.4 to 14.0 | 12 m |
| | | A* | 12.8 to 13.4 | 11 m |
| 5 max. slab of 12.6 m | 2,099 | B* | 12.1 to 12.6 12.6 to 12.8 | 11 m |
| | | C | 11.5 to 12.1 | 10 m |
| | | D | 10.9 to 11.5 | 9 m |
| | | A* | 10.2 to 10.9 | 8 m |
| 4 max. slab of 10.0 m | 1,719 | B* | 9.6 to 10.0 10.0 to 10.2 | 8 m |
| | | C | 9.0 to 9.6 | 7 m |
| | | D | 8.4 to 9.0 | 6 m |
| | | A* | 7.7 to 8.4 | 5 m |
| 3 max. slab of 7.5 m | 1,339 | B* | 7.1 to 7.5 7.5 to 7.7 | 5 m |
| | | C | 6.5 to 7.1 | 4 m |
| | | D | 5.8 to 6.5 | 3 m |
| | | A* | 5.2 to 5.8 | 2 m |
| 2 max. slab of 5.0 m | 959 | B* | 4.6 to 5.0 5.0 to 5.2 | 2 m |
| | | C | 3.9 to 4.6 | 1 m |
| | | D | 3.3 to 3.9 | 0 m |
| | | A* | 2.7 to 3.3 | 0 m |
| 1 max. slab of 2.5 m | 579 | B* | 2.0 to 2.5 2.5 to 2.7 | 0 m |
| | | C | 1.4 to 2.0 | 0 m |
| | | D | 0.8 to 1.4 | 0 m |
| | | A* | 0.8 to 1.4 | 0 m |

A*, B*: Position the upper module to access the last 4 steps

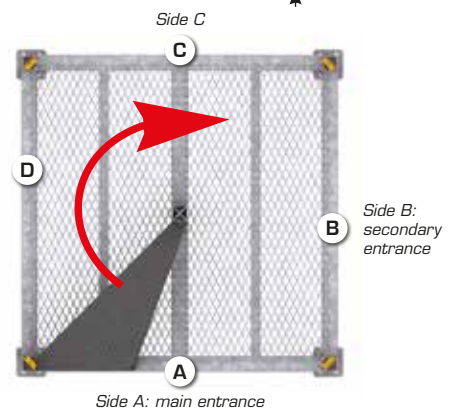

Example 1: Height of slab to be served 4.50 m, EscAlpha MDS consisting of 2 modules. Exit side C on second module.

Example 2: Height of slab to be served 5.50 m, EscAlpha MDS consisting of 3 modules. Exit side A on second module.

USER GUIDE: ASSEMBLY RAIL IN CLOSED POSITION



The assembly rail is placed in the horizontal position under the effect of gravity. This allows secure slinging and installation and removal of a module and the closing guardrail.

- Slinging.



- Installation or removal of a module.



- Installation or removal of closing guardrail.

CAUTION

- The assembly rail cannot act as a substitute for the closing guardrail.

ASSEMBLY RAIL IN OPEN POSITION



To free the passage, the assembly rail is locked vertically upwards.
- On the 1st step of the upper module.

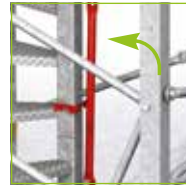

- Locking on the closing guardrail.

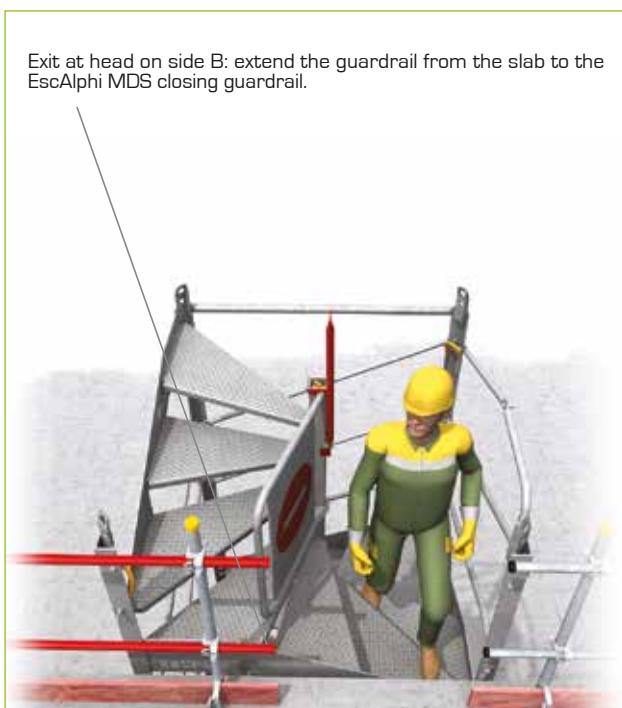

- On the closing guardrail when the exit is at this level.

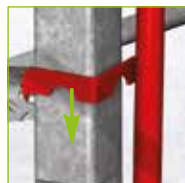

- Locking on the step of the upper module.

CAUTION

- The assembly rail cannot act as a substitute for the closing guardrail.
- During transportation, return the assembly rail to the horizontal position so as not to exceed a size suitable for road transport.

WARNING

- Make sure that the ground level intended to receive the EscAlphi MDS is capable of withstanding the loads.
- General handling and stability guidelines must be adhered to.
- The assembly rail cannot act as a substitute for the closing guardrail.
- Fit tethers as assembly progresses.
- Perform disassembly in the reverse order of assembly.



USER GUIDE: ASSEMBLY AND DISASSEMBLY EXAMPLE OF AN ESCALPHI MDS WITH 3 MODULES



- Orient the base according to height of slab to be served (the sides are indicated on the self-adhesive label).
- Installation 8 cm from the wall to facilitate tilting of the guardrail at the exit.
- Level the base.



Intermediate modules: steps 2 to 5

- Enter the module to attach the sling to the central ring, with the guardrail in the closed position and the assembly rail in the horizontal position.



- Fit the module onto the base.
- Assemble the 4 risers with M24 screws.
- Detach the sling.



- Position a new module.



- Rotate the assembly rail into the vertical position and lock on the top step.
- Assemble the risers with M24 screws.
- Detach the slings.
- Repeat steps 2, 4 and 5 if required, tethering the EscAlphi MDS as assembly progresses.



Head module: steps 6 to 8

- Position and bolt the closing guardrail: the assembly rail is in the horizontal position.

USER GUIDE: ASSEMBLY AND DISASSEMBLY



- With the slings attached to the 2 hoisting rings, position the head module.
- Assemble the 4 risers with M24 screws.



- Make sure that the tethers are fitted before detaching the slings.
- Tilt the guardrails to create the exit at the desired level.



- At the entrances, position the rails, prioritising the main entrance on side A (the sides are indicated on the self-adhesive label).



- N.B.: Ideally, the last step used is positioned 21 cm below the slab to be served.

WARNING

- Make sure that the ground level intended to receive the EscAlphi MDS is capable of withstanding the loads.
- General handling and stability guidelines must be adhered to.
- The assembly rail cannot act as a substitute for the closing guardrail.
- Fit tethers as assembly progresses.
- Perform disassembly in the reverse order of assembly.



USER GUIDE: HOISTING AND MOVING (NOT MORE THAN 8 STACKED MODULES)

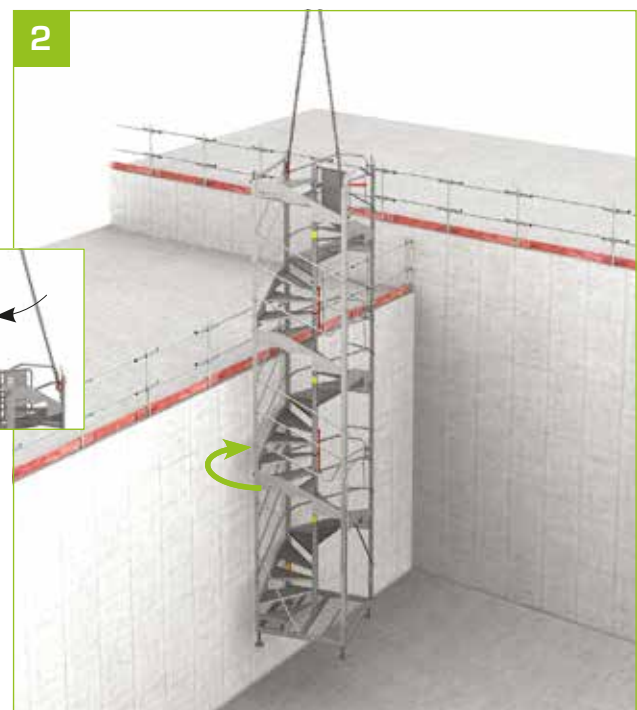
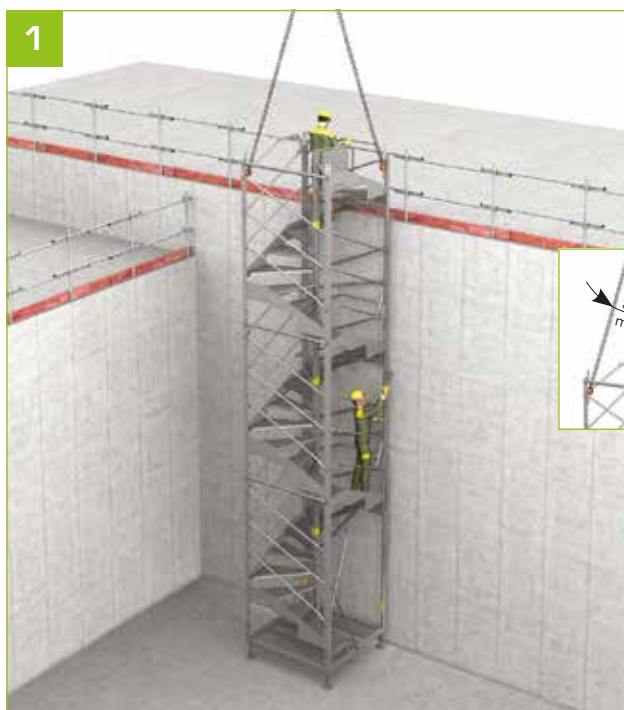

- Put the guardrails back in place to prevent any side exit.
- Check that the M24 screws are fastened.
- Attach the crane hooks onto the 2 hoisting rings.
- Remove the tethers.

- Moving the EscAlphi MDS.
- Orientation according to the height to be served by pivoting in 90° increments.
- Installation 8 cm from the wall to facilitate tilting of the guardrail at the exit.

USER GUIDE: HOISTING & MOVING



- Ground positioning and levelling of EscAlphi MDS.

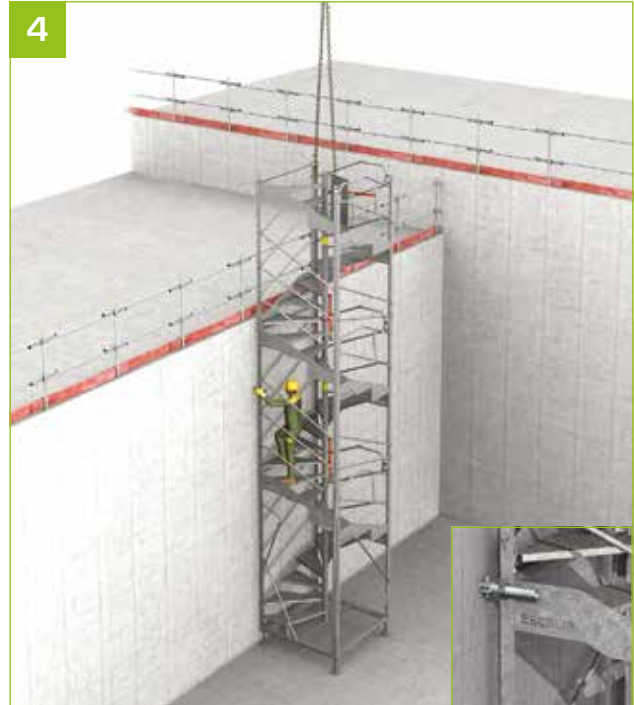

- Tether the EscAlphi MDS before detaching the slings from the crane.



- At the entrances, position the rails, prioritising the main entrance on side A [the sides are indicated on the self-adhesive label].



- Make sure that the tethers are fitted before detaching the slings.
- Tilt the guardrails to create the exit at the desired level.

TECHNOLOGY AND STRENGTH

To facilitate the sizing of the tethers and base for EscAlphi MDS, the loads carried to the ground and forces applied to the tethers have been calculated, based on the different configurations.



Wind zone map

TETHER LAYOUT

If "d" is greater than 20 cm, it may be necessary to reinforce the tethering system with crossbracing. Configuration 2 requires a specific design. For a given direction, the forces in both directions are to be taken into account.

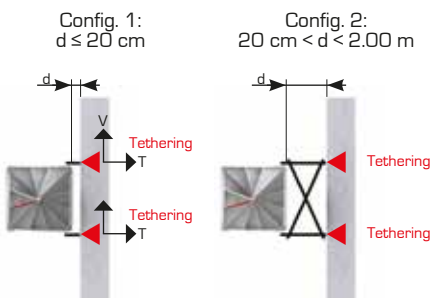

Assumptions

- 1 - Wind effect W , as per the NF EN 1991-1-4 standard:
 - Period of wind exposure greater than 1 year.
 - $C_o = 1$
 - $\phi = 0.23$ and $C_f = 2.73$
- 2 - Operating load Q , as per the NF P 93-521 standard:
 - Not more than 8 people per EscAlphi MDS module.
 - Not more than 20 people on all EscAlphi MDS modules.
 - Staircase not in use in wind speeds exceeding 65 km/h.
- 3 - Tare weight P of EscAlphi MDS.

LOADS CARRIED TO GROUND AND FORCES IN TETHERS

The results are given as SLS.
To obtain ULS values: **1.5 x SLS**

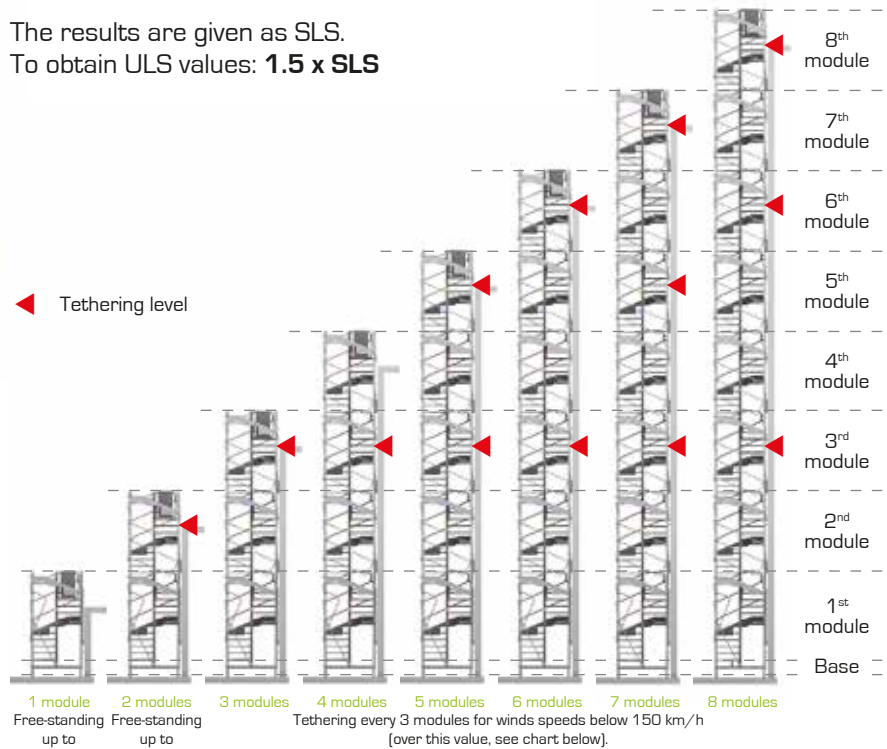

| Wind type by region | | Force W (+/-daN) in tethers for configuration 1 | | | | | | | | | | | | | | | |
|---------------------|---|---|-----|-----|-----|-----------------|-----|-----|-----|-----------------|-----|-----|-----|-----------------|-----|-----|-----|
| | | 1 and 2 modules | | | | 3 and 4 modules | | | | 5 and 6 modules | | | | 7 and 8 modules | | | |
| | | 1 | 2 | 3 | 4 | 1 | 2 | 3 | 4 | 1 | 2 | 3 | 4 | 1 | 2 | 3 | 4 |
| Cat. 0 | V | 233 | 276 | 324 | 376 | 407 | 484 | 569 | 623 | 707 | 843 | 593 | 688 | 551 | 534 | 627 | 728 |
| | T | 169 | 200 | 234 | 272 | 358 | 426 | 500 | 365 | 367 | 436 | 363 | 421 | 377 | 336 | 394 | 457 |
| Cat. II | V | 180 | 213 | 250 | 290 | 330 | 393 | 460 | 534 | 588 | 700 | 825 | 573 | 467 | 555 | 530 | 615 |
| | T | 130 | 155 | 180 | 210 | 291 | 346 | 405 | 470 | 305 | 363 | 427 | 351 | 319 | 379 | 334 | 387 |
| Cat. IIIa | V | 134 | 159 | 186 | 216 | 259 | 308 | 362 | 419 | 474 | 565 | 664 | 771 | 383 | 456 | 536 | 506 |
| | T | 97 | 115 | 135 | 156 | 228 | 272 | 319 | 369 | 246 | 293 | 344 | 399 | 262 | 312 | 367 | 318 |
| Cat. IIIb | V | 123 | 146 | 171 | 198 | 200 | 238 | 279 | 324 | 378 | 451 | 529 | 614 | 313 | 372 | 435 | 505 |
| | T | 89 | 106 | 124 | 144 | 176 | 210 | 246 | 285 | 196 | 234 | 275 | 319 | 213 | 254 | 297 | 345 |
| Cat. IV | V | 117 | 140 | 164 | 189 | 179 | 213 | 250 | 289 | 293 | 349 | 409 | 476 | 248 | 295 | 346 | 401 |
| | T | 85 | 101 | 119 | 137 | 157 | 188 | 221 | 255 | 153 | 182 | 212 | 247 | 169 | 201 | 236 | 274 |

For these configurations (wind >150 Km/h), retighten the tethers every 2 modules.
Site environment: Cat.0: seafront - Cat. II: open countryside - Cat. IIIa: wooded countryside - Cat. IIIb: densely wooded countryside or industrial area - Cat. IV: town/ city or forest [refer to NF EN 1991-1-4 standard].

| Loads carried to the ground P+Q [daN / base] | | | | |
|--|-----------|-----------|-----------|-----------|
| 1 module | 2 modules | 4 modules | 6 modules | 8 modules |
| 335 | 871 | 1,318 | 1,499 | 1,682 |

Example: For an EscAlphi MDS with 8 modules in Paris (zone 2, site category IV), the EscAlphi MDS should be tethered in config. 1, every three height modules.

The SLS forces applied for each anchoring device will be:
 - parallel to wall: $V = 295$ daN,
 - perpendicular to wall: $T = 201$ daN.

CAUTION:
 If the anchoring devices used do not withstand the calculated load, multiply the number of tethering levels.

GANGWAYS

For EscAlphi MDS staircases at a distance from the slabs to be served, specific supports can be used to fit gangways made of scaffolding elements.

The 2 gangway supports (left and right) are placed on the stringers of EscAlphi MDS connected by a 1.50 m scaffolding rail.

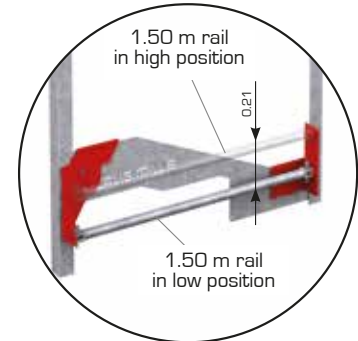

EXAMPLES OF GANGWAYS WITH FRONT EXITS

Entry on slab

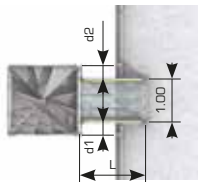

Entry over parapet

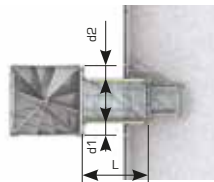

Gangway over skin

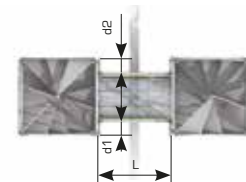

| Main components | Gangway support | | Weight (kg) | Catalogue Number |
|---|---|---|------------------|------------------|
| | Left | Right | | |
| |  |  | 13.0 | 013271-2 |
| | | | 9.0 | 013270-4 |
| | 1.50 m rail | | Weight (kg) | Catalogue Number |
| |  | | 5.80 | 023609-1 |
| Load support collar | | Weight (kg) | Catalogue Number | |
|  | | 1.50 | 025620-6 | |

→ For other scaffolding parts, see technical data sheet.

GANGWAY FROM FRONT EXIT (EXCEPT 0.38 - 0.22 M OFFSET GANGWAY)

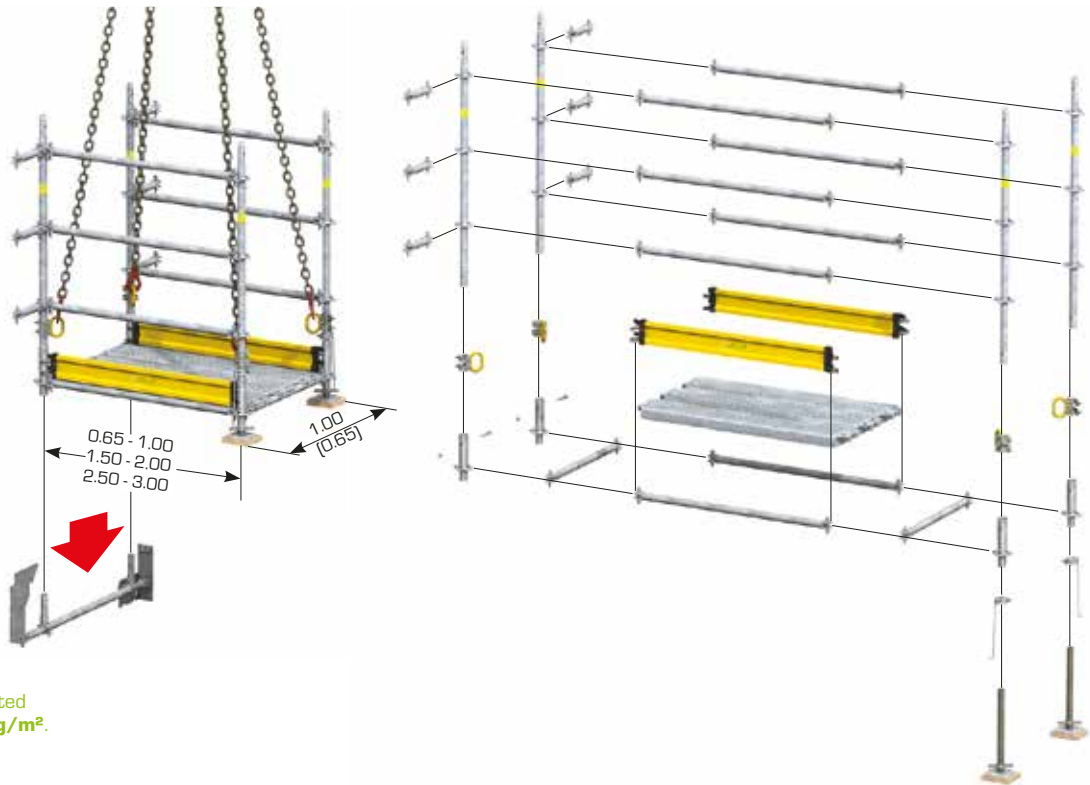

→ N.B.: Evenly distributed working load: **200kg/m²**.

CRANE INSTALLATION OF FRONT-EXIT GANGWAY

A safety harness (PPE) must be worn for all installation phases.



- Install the left and right gangway supports. Depending on the configuration, install the 1.50 m rail up or down on the supports and position the load support collars 0.30 m (or 0.15 m) from the module riser.



- With a safety strap attached to the upper tie-bar, tilt the guardrails to enable gangway installation.



- Remove the slab edge guardrail.
 - Install the gangway.
 - Remove the jack collars temporarily to adjust the height.
 - Fasten the load support collars.
CAUTION: Tether the EscAlpha MDS to the gangway.

→ N.B.: To facilitate gangway installation, fasten the load support collars firmly once they have been fitted.

GANGWAYS

EXAMPLES OF GANGWAYS WITH SIDE EXITS

If an EscAlphi MDS is used to access multiple levels, the exits may be located on different sides (A, B, C, D). The "gangway supports" enable creation of gangways with brackets, scaffolding, connecting the lateral side and the slab.

It is thus possible to access all the slabs regardless of the orientation of the EscAlphi MDS.

→ N.B.: Option to handle gangways with a crane with 4 hoisting rings mounted at the base of the risers.



CAUTION

- Tether the EscAlphi MDS to the brackets.
- Assembly with safety harness (PPE).



- The bracket-based gangway is supported by 2 x Ø49 tubes mounted at the lower level on a 1.50 m rail rigidly connected to 2 "gangway supports".

EXAMPLES OF SPECIFIC CASES...

SUSPENDED ESCALPHI MDS

The EscAlphi MDS can be suspended. Resting on HEB beams in a cantilever configuration, the modules are assembled and positioned using a crane to create quick access to the groundworks floor.

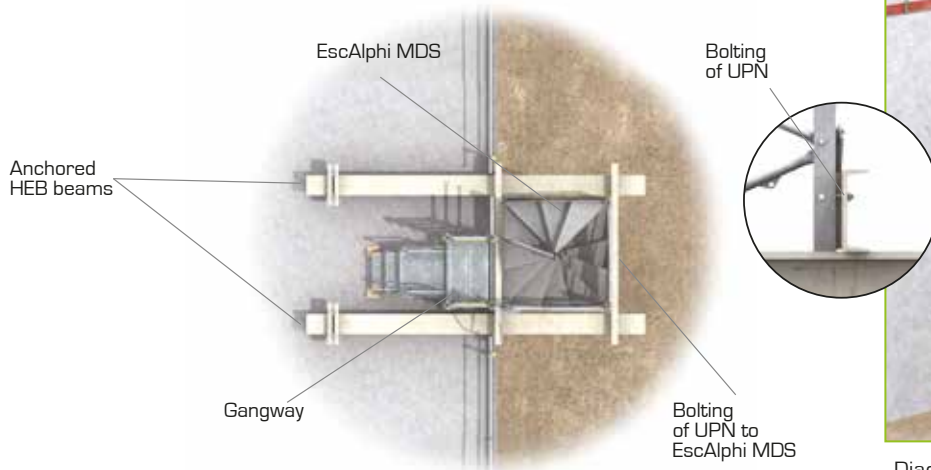

- Diagram of suspended EscAlphi MDS for groundworks floor access.

EscAlphi MDS extension principle for groundworks floor



- On the module in position, place the assembly rail in the horizontal position and remove the closing guardrail.
- Install a new module pre-equipped with a closing guardrail and UPN beams.



- Assemble the modules.
- Return the assembly rail to the vertical position.
- Tension the crane slings.
- Remove the tethers and the 2 UPN beams resting on the HEB beams.



- Lower the EscAlphi MDS until the 2 new UPN beams are resting on the HEB beams.
- Install the tethers.

ESCALPHI IN KIT FORM

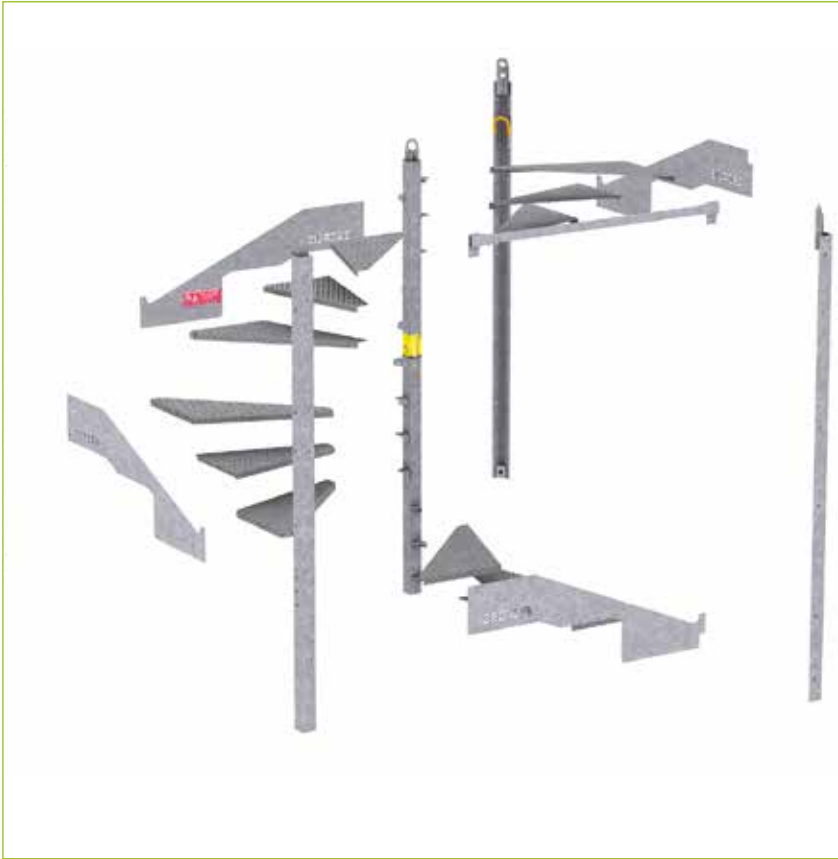

- To enable container transportation, bolted versions of EscAlphi MDS modules are also available. They are geometrically identical to the welded version and perfectly compatible.
- The risers, stringers and steps are supplied as spare parts, ready to be assembled.



- The base is used as a template for assembly. Once the assembly has been bolted, the guardrail rails need to be assembled as for a standard module.

- Detailed assembly instructions are supplied with the equipment, making the operation quick and easy.
- Modules in kit form are supplied with the tools and fasteners required.
- The technical data in respect of strength, use and assembly specified in this document remain valid.



TRANSPORTATION

For transportation, EscAlpha MDS must be loaded as shown opposite, with the whole strapped firmly to prevent any risk of tipping during transportation.

Each EscAlpha MDS module is positioned upright (1.68 x 1.68 m overall). If required, position the bases on their side, alongside the modules. The modules can be transported equipped with the closing guardrails.

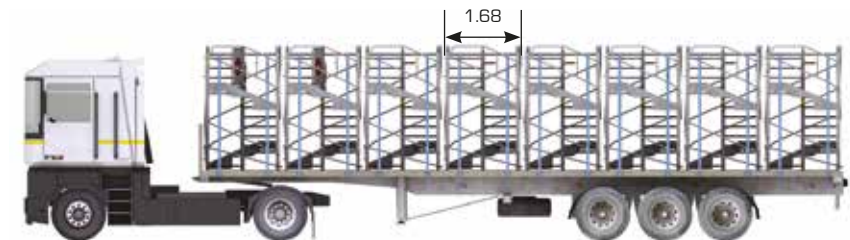

Example of loading of EscAlpha MDS.
 - Standard deck (12 m): 7 modules and 7 bases.
 - Extended deck (13.50 m): 8 modules and 8 bases.

Assembly rail in horizontal position

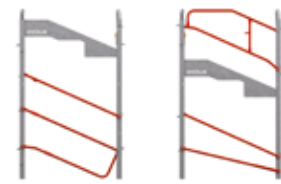
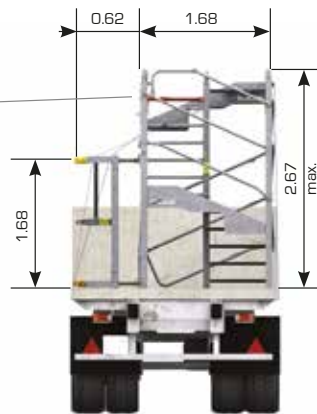

Side A

Side B

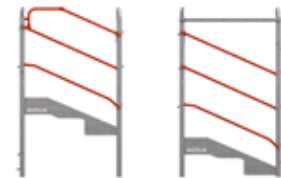

Side C

Side D

Rail position to be locked in transportation mode.

PRECAUTIONS

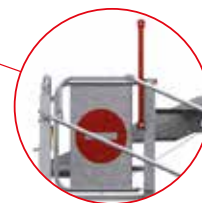

So as not to exceed a size suitable for road transport, do not stack the module onto the base and return the assembly rail to the horizontal position.



CAUTION

- During transportation, do not stack the bases for stability reasons.
- Strap to the stringers and not to the rails.

- Do not store or transport EscAlpha MDS or the modules horizontally to prevent damage.

ALPHI, THE WORKSITE SAFETY SPECIALIST



EscAlphi MDS is a metal spiral staircase with side exit. Access to levels is easy and secure, by means of a triangular step acting as a landing. Assembly and disassembly are performed in complete safety, with collective protection.

Savoie Hexapole, Actipole 5 - 242, rue Maurice Herzog
73420 Viviers-du-Lac
FRANÇA

Tel.: 0033 4 79 61 85 90 - Fax: 0033 4 79 61 85 99 - info@alphi.fr

Gabinete de estudos: Tel.: 0033 4 79 61 85 91 - be@alphi.fr

Serviço logístico: Tel.: 0033 4 79 61 85 92

Alphi
Formwork and solutions

Designed in France 

www.alphi.fr