

AlphiTorre

SHORING



SAFETY



SIMPLICITY



PRODUCTIVITY



INNOVATION

THE SHORING TOWER
WITH BUILT-IN SAFETY FEATURES

AlphaTorre | The shoring tower with built-in safety features



AlphiTorre

Changes in French and European tower regulations have led Alphi to focus on a new shoring tower for construction work.

The AlphiTorre tower is innovative in its **safety and ease of use**, and its lightweight components.

Its compatibility with scaffolding elements means that cross-bracing, connections and decking between towers can easily be created.



Site:
National
Library of
Luxembourg
Client: Tralux
Location: Kirchberg

AlphiTorre | The shoring tower with built-in safety features

SIMPLICITY

Four identical frames per level

Each frame incorporates:

- safety: riser, sill, access ladder,
- automatic locking without pin,
- hoisting eye identified by yellow marking.
- The assembly kinematics are simplified by the single frame, with the same parts being used for each level.



SPEED

1 single plank

- Plank with trapdoor covering half the surface area of a level.
- Unit weight of handled parts less than 15 kg to reduce repetitive strain injury.

**COMPLIANT
WITH CRAMIF
NT24 GUIDELINES**





STURDINESS

- The brackets enable strong load support.
- Load support of 6 tonnes per base, regardless of the configuration.

BUILT-IN SAFETY FEATURES

- Plank covering between towers for formwork and formwork removal operations. The work surface created is perfectly secure.
- Plank covering at the head of the towers to link the girders.



Brackets on AlphaTorre





ADAPTABILITY



- All configurations are possible: height difference at head, at bases, between towers.
- The components are all compatible and make it possible to combine frames of different sizes to obtain a tower assembly as close as possible to requirements.

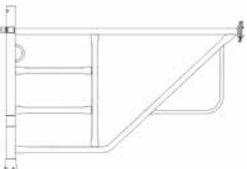



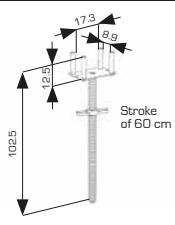

Height difference at bases

COMPONENTS





Frames	1.50 m frame	Catalogue Number	Dimensions h x L (m)	Weight (kg)
		011156-7	1.00 x 1.50	12.40
	1.00 m frame	Catalogue Number	Dimensions h x L (m)	Weight (kg)
		011106-2	1.00 x 1.00	10.80
	1.50 m entrance frame	Catalogue Number	Dimensions h x L (m)	Weight (kg)
		011157-5	1.00 x 1.50	11.50
	1.00 m entrance frame	Catalogue Number	Dimensions h x L (m)	Weight (kg)
	011107-0	1.00 x 1.00	8.40	



Jacks	2-inlet head jack	Catalogue Number	Stroke (cm)	Weight (kg)
		011100-5	60	9.00
	Base jack	Catalogue Number	Stroke (cm)	Weight (kg)
	011155-9	49	9.20	

Traffic	Plank with trapdoor	Catalogue Number	Dimensions (m)	Weight (kg)
		011104-7	1.00	11.30
		011154-2	1.50	14.80
	Steel toeboard	Catalogue Number	Dimensions (m)	Weight (kg)
		023724-8	From 1.00 to 3.00	From 1.60 to 5.60
	Steel floor	Catalogue Number	Dimensions (m)	Weight (kg)
		110021-3	1.00 x 0.20 (Steel panel)	7.90
		115021-8	1.50 x 0.20 (Steel panel)	9.20
		025602-4	1.00 x 0.25	4.70
		023621-6	1.50 x 0.25	7.20
023624-0		2.00 x 0.25	9.20	
023625-7		2.50 x 0.25	14.80	
023626-5		3.00 x 0.25	17.00	
023684-4		1.00 x 0.30	5.00	
023680-2		1.50 x 0.30	8.00	
023681-0		2.00 x 0.30	10.50	
023682-8	2.50 x 0.30	16.70		
023683-6	3.00 x 0.30	19.50		

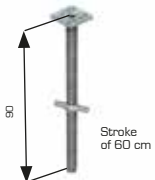
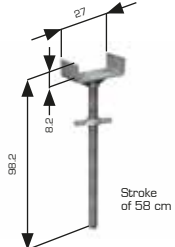
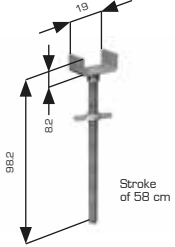
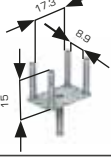
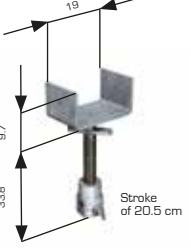

Additional equipment	Diagonal	Catalogue Number	Dimensions H x L (m)	Weight (kg)	Spacing (m)
		295010-3	0.50 x 1.00	2.90	1.04
		295015-2	0.50 x 1.50	3.70	1.49
		251007-1	1.00 x 0.70	3.10	1.17
		251010-5	1.00 x 1.00	3.80	1.35
		251015-4	1.00 x 1.50	4.30	1.72
		251020-4	1.00 x 2.00	5.70	2.15
		251025-3	1.00 x 2.50	6.50	2.60
		252007-0	2.00 x 0.70	5.50	2.09
		252010-4	2.00 x 1.00	5.60	2.19
		252015-3	2.00 x 1.50	6.30	2.45
		252020-3	2.00 x 2.00	7.20	2.76
		252025-2	2.00 x 2.50	7.30	3.13
	252030-2	2.00 x 3.00	9.20	3.53	
Bracket	Catalogue Number	Description	Weight (kg)		
	011152-6	0.38 m bracket	4.40		
	250710-1	1.00 m bracket	8.00		
	250000-7	Connector	2.20		
Connector	Catalogue Number	Dimensions (m)	Weight (kg)		
	250230-0	From 0.15 to 3.00	From 0.90 to 9.60		

ALPHITORRE ACCESSORIES

Additional	Simple post	Catalogue Number	Dimensions (m)	Weight (kg)
		011170-8	0.50	2.80
		011171-6	1.00	5.10
	Riser	Catalogue Number	Dimensions (m)	Weight (kg)
		250101-3	1.00	5.30
		250102-1	2.00	9.60
	Linking pin (for riser)	Catalogue Number	Weight (kg)	
		021009-6	0.25	
	Base	Catalogue Number	Weight (kg)	
		011169-0	1.80	
AlphiTorre stud-free base	Catalogue Number	Weight (kg)		
	011192-2	3.30		

Additional materials for head jacks	Head jack	Catalogue Number	Stroke (cm)	Weight (kg)
		050120-5	60	8.50
	Jack triple fork	Catalogue Number	Stroke (cm)	Weight (kg)
		192460-4	58	11.20
	Jack fork	Catalogue Number	Stroke (cm)	Weight (kg)
		011153-4	58	9.10
	Four-inlet fork	Catalogue Number	Stroke (cm)	Weight (kg)
		050100-7	-	3.50
	T1 head jack (MT65)	Catalogue Number	Stroke (cm)	Weight (kg)
		024628-0	20.5	7.20
1-clamp U-bracket	Catalogue Number	Weight (kg)		
	251001-4	0.75		

ALPHITORRE ACCESSORIES

Safety	MDS guardrail	Catalogue Number	Height (m)	Weight (kg)
		256070-4	0.70	5.90
		256100-9	1.00	6.30
		256150-4	1.5	10.10
		256200-7	2.00	11.40
		256250-2	2.50	13.20
		256300-5	3.00	15.00
	Clinch-fit guardrail	Catalogue Number	Dimensions h x L (m)	Weight (kg)
		011110-4	2.17 x 1.10	12.00
		011115-3	1.85 x 1.52	13.90

Handling	Storage container	Catalogue Number	Weight (kg)	MWL (daN)	Description
		011165-8	110.00	1,500	Medium capacity: <ul style="list-style-type: none"> 1.00 m connector: 210 1.50 m connector: 130 2-inlet head jack: 50 base jack: 100
	20-frame rack	Dimensions (m)	Catalogue Number	Weight (kg)	Description
		1.00	011159-1	77.40	<ul style="list-style-type: none"> Loading of 20 classic or entrance frames (1.00 m or 1.50 m).
		1.50	011160-9	84.00	
	13-plank rack	Dimensions (m)	Catalogue Number	Weight (kg)	Description
		1.00	011158-3	56.00	<ul style="list-style-type: none"> Loading of 13 trapdoor floor planks (1.00 m or 1.50 m).
		1.50	11161-7	60.00	
	Shifting trolley	Dimensions (m)	Catalogue Number	Weight (kg)	Description
		0.90 x 1.20	050103-1	20.00	<ul style="list-style-type: none"> Moving on a concrete slab for heights less than 3 frames
Shifting trolley with jack	Dimensions (m)	Catalogue Number	Weight (kg)	Description	
	1.50 x 1.50	011167-4	106.00	<ul style="list-style-type: none"> Suitable for 1.0 and 1.50 m meshes. 	
AlphiTorre wheel (with base)	Dimensions (m)	Catalogue Number	Weight (kg)	Description	
	0.50 / 0.823	011190-6	8.50	<ul style="list-style-type: none"> 200 kg max on mobile equipment = workers with tools 	

BUILT-IN SAFETY FEATURES & COLLECTIVE PROTECTION GUARANTEED

"FRAME": THE BENEFITS OF BUILT-IN SAFETY FEATURES

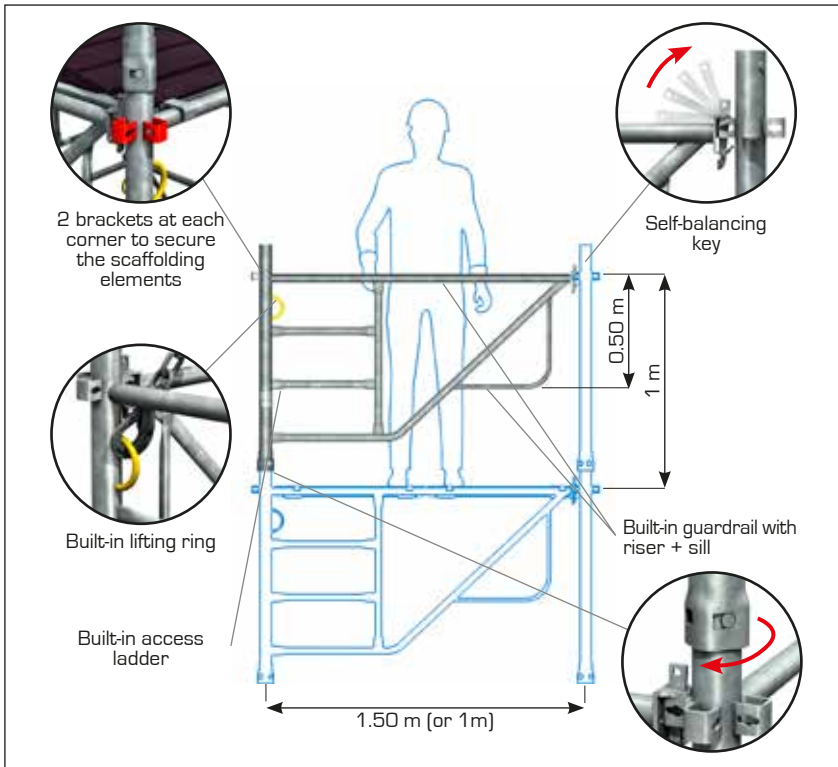

The design of AlphiTorre is based on a triangular frame. The frame incorporates all the safety features: riser, sill, access ladder, automatic locking and a lifting ring to secure movements using a crane.

The AlphiTorre frame weighs 12.4 kg.

Built-in automatic locking by rotation:
 - between frames,
 - between frame and base jack.
Movement with a crane is secured.

"TOWER": COLLECTIVE PROTECTION GUARANTEED

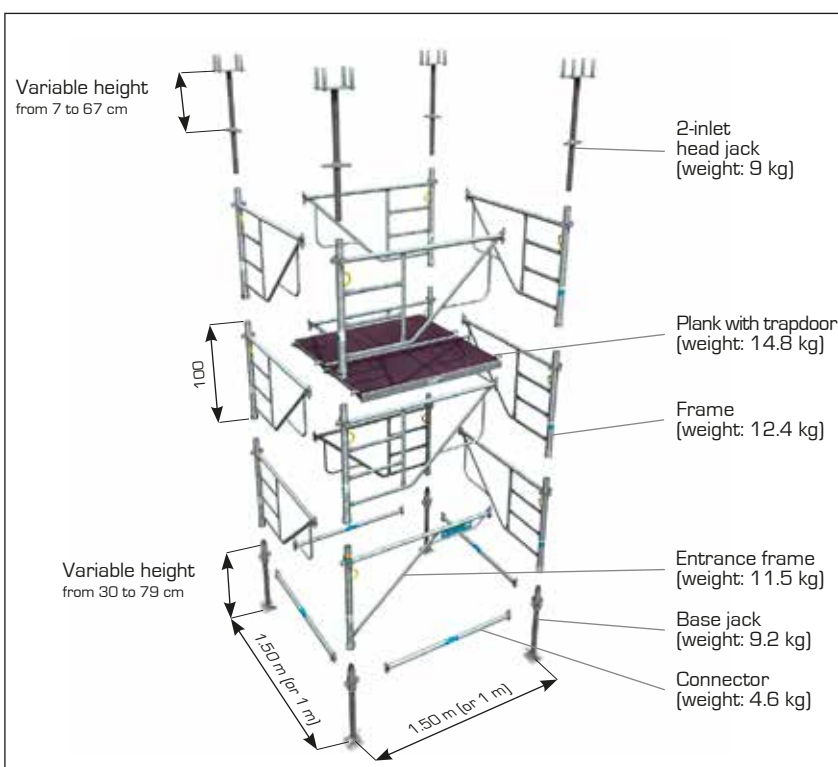

With no slides or parts that can fall off, the whole assembly is self-locking and can be moved using a crane.

REGULATIONS AND STANDARDS APPLICABLE TO SHORING

The transposition of the new European directives by the Decree of 1 September 2004 did not result in the revocation of Article 218 concerning shoring towers in the decree of 8 January 1965.

This means that, for the time being, there are no explicit requirements in terms of training, design justification and checking of shoring systems as set out in the Decree of 1 September 2004 or the Order of December 2004 for scaffolding.

The Decree of 8 January 1965 is still in force for shoring.

ALPHITORRE
IS MANUFACTURED
IN FRANCE
IN COMPLIANCE
WITH NF MARK
GUIDELINE
REQUIREMENTS

DECREE OF
8 JANUARY 1965

The design of shoring systems more than 6 metres tall must be supported by a design document, and they must be built in accordance with a previously established assembly drawing, except in case of an emergency or should this be impossible.

The design document and the assembly drawing must be kept on the worksite [article 218].

NORMATIVE TEXTS

"Load bearing towers of prefabricated components":

European standard NF EN 12813 has replaced the NF P93-550 standard of December 1987 but does not allow for the evaluation of the compliance of shoring towers. For this reason, the special committee for the NF Mark decided to implement and publish French standard NF P93-551 in May 2016.

This French standard will complement the European standard in two ways:

- by defining a design method for Eurocodes and the relevant tests,
- by adding technical specifications related to the safe assembly and use of shoring towers.

AlphiTorre is manufactured in accordance with NF Mark standards. This Mark stipulates monitoring and follow-up of manufacture by AFNOR Certification (conducting audits of production units and tests during production).

CRAMIF TECHNICAL REPORT NO. 24 DATED 2007

The purpose of this document is to improve shoring tower user safety. Some excerpts are provided below:

Against the risks of falling from height

- By design, towers must allow **safe assembly, disassembly and use.**
- The jack adjustment and purlin installation operations must be feasible from the last floor, which consists of connecting elements covering the entire surface of the tower. **A trapdoor allows access.**

Note: A risk assessment is performed to confirm that the installation of baseboards is not necessary during assembly, disassembly, access and adjustment operations when the floors are non-slip.

- When the towers are assembled in rows, to supply on request **gangways with guardrails for access from one tower to another.**

Against the risk of repetitive strain injury

- **Reduce** insofar as possible the **weight of the components** and the number of parts making up the towers.
- Design the tower in order that **it is possible and easy to move it using a crane.**

Against the risks of falling from ground level

- Incorporate **means of access** inside the tower so that they can be used at **every level.**
- Improve the ergonomics of access inside the base of the tower.

Against miscellaneous handling and manoeuvring risks

- Securely fasten the base jack to the tower by **built-in locking.**
- Attach the pinning systems to the elements so that **they cannot be lost.**

RECOMMENDATIONS

EQUIPMENT INSPECTION

Before starting assembly:

- check that the equipment is in good condition,
- remove any equipment that is in a doubtful condition (twisted, crushed, detached components, etc.),
- for towers, reject any parts from other shoring systems. Parts from different sources must not be combined.

PREFER PERMANENT COLLECTIVE PROTECTION

When designing the assembly and disassembly of the shoring and formwork, collective protection must be preferred. If, under certain circumstances, it cannot be completely or partially set up, individual protection must be provided to workers using a fall prevention system.

RECOMMENDATIONS

When assembly is complete, the shoring must be the subject of a formal acceptance report.

STRIKE-DOWN

To avoid destabilising the towers, it is preferable to perform strike-down at the head jacks. All the jacks should be gradually unfastened together to avoid load transfers.

FORMWORK

The formwork design should take continuity effects into account. The continuity of a beam on 3 supports, for example, results in a load distribution on the supports which is different to mere geometric distribution.

STABILITY DURING ASSEMBLY PHASES

It is essential to check the stability of all the shoring during the assembly and disassembly phases, or an intermediate phase before casting, when the formwork has a wind surface area and the concrete load is not present to act as ballast.



DISTRIBUTION ON THE GROUND - FOUNDATION

Loading on concrete slab

Loading on a concrete slab generally requires no special preparation. If the surface condition is irregular, then a wooden plank must be inserted between the base and the concrete.

It may be necessary to undershore the lower floors if they are unable to support the descending loads.

Loading on natural ground

On natural ground, it is essential to provide load distribution on the ground, according to its nature and the intensity of the load.

Differential settling

It is important to ensure that the four bases of the towers rest on a uniform support so that settling is identical under each base.

If this is impossible, for example, two bases on concrete slab and two bases on natural ground, the distribution under the bases on natural ground must be oversized to reduce settling as much as possible.



Excessive chock stacking

Resting on a void

Resting on a hollow body

CAUTION: Always avoid resting the bases on drain plates, pipe covers, or ground of unknown composition.

In these specific cases: either change the installation location of the shoring or reinforce the distribution base plates after obtaining approval.

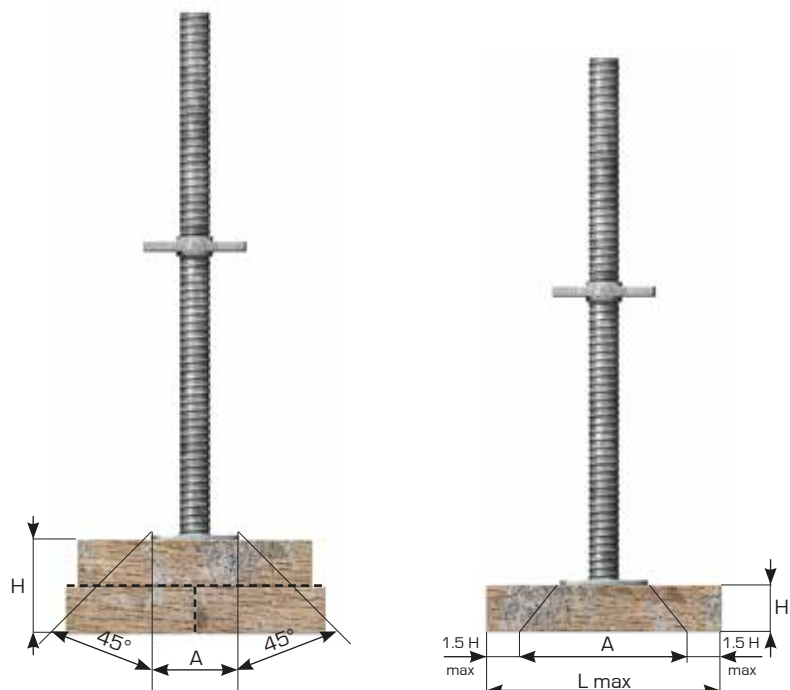

To ensure shoring stability, particular attention must be paid to the nature and resistance of the ground.

WARNING

- Take care regarding the distribution on the ground.
- Place the base perfectly level.
- Assemble the first level of frames from inside the tower.
- Position the trapdoor opposite the ladder.
- Make sure the towers are stable.
- Centre the load in the forks.
- Make sure the jacks are vertical
- Perform the disassembly phases in the reverse order of assembly.



USER GUIDE: ASSEMBLING A 1.50 X 1.50 M TOWER

1



- Location and levelling.

2



- From the inside of the tower, install the 1st frame in the diagonal axis and then rotate to lock.

3



- Install the entrance frame to facilitate access.

4



- Install two 1-m planks with trapdoor and assemble the 2nd level.

5



- Assemble one floor level in temporary position.
- Install a 1st 1-m plank with trapdoor.

6



- Access to the upper level and then installation of the 2nd plank with trapdoor.

USER GUIDE: ASSEMBLING A 1.50 X 1.50 M TOWER

7



- Assemble the 3rd level.

8



- Reinstall the planks with trapdoor in their final position to obtain 2.00m between floor levels.
- Moving the 1st plank with trapdoor.

9



- Moving the 2nd plank with trapdoor from the lower level.

10



- The first floor level can be removed. Access to the upper level via the built-in ladder.

11



- Set up and adjust the head jacks.

COMPOSITION CHART

Tower 1.50 x 1.50 m	Number of frame levels	1	2	3	4	5
	Minimum height (m)	1.82*	2.37	3.37	4.37	5.37
	Maximum height (m)	2.46	3.46	4.46	5.46	6.46
	Base jack	4	4	4	4	4
	1.50 m connector	4	4	4	4	4
	1.50 m entrance frame	1	1	1	1	1
	1.50 m frame	3	7	11	15	19
	2-inlet head jack	4	4	4	4	4
	1.50 m trapdoor plank with trapdoor	0/2	2	2**	4	4
	Weight (kg)	140/170	220	270	350	400

Tip for counting
= number of levels + 0.37 m
= number of levels + 1.46 m
= 4
= 4
= 1
= [number of levels x 4] - 1
= 4

*Minimum height determined by the length of the two jacks

**Allow two additional floor planks with trapdoor for assembly

USER GUIDE: ASSEMBLING A 1.50 X 1.50 M TOWER

ASSEMBLING A ALPHITORRE WITH 1, 3 AND 5 LEVELS (ODD) OF FRAMES

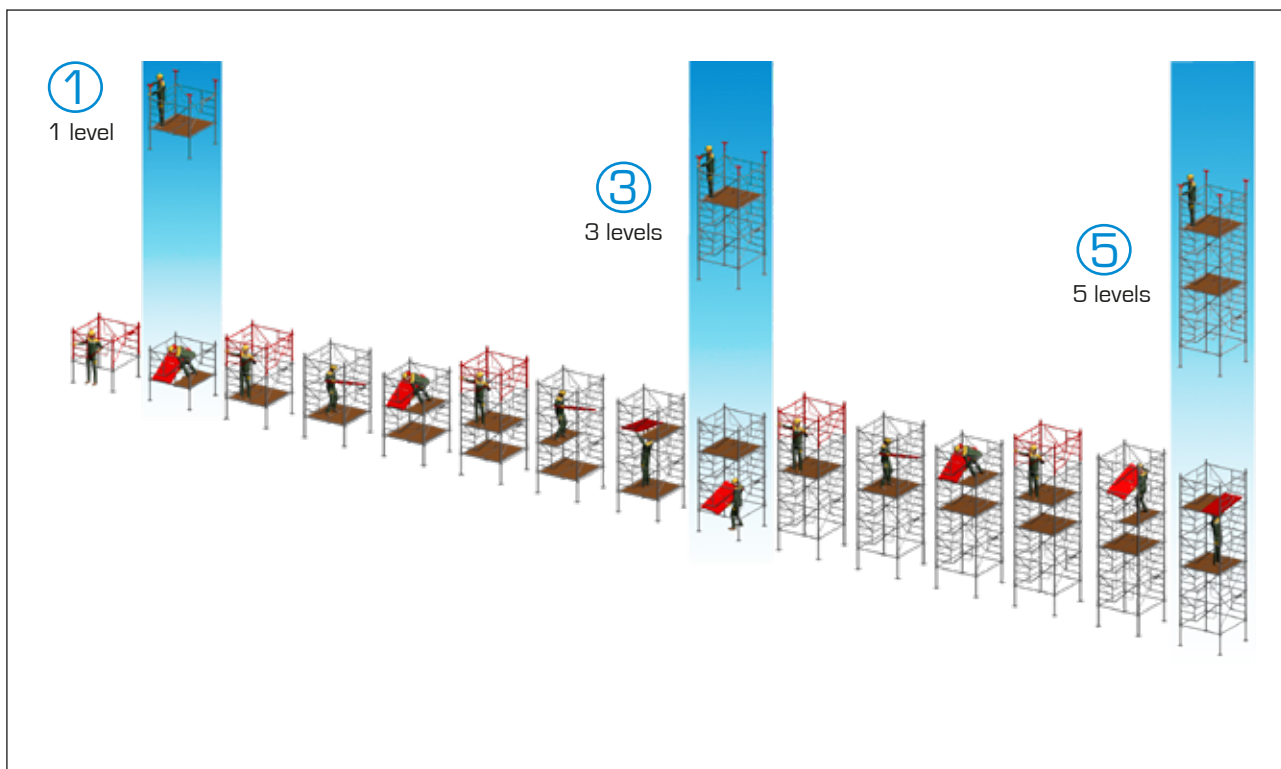

ASSEMBLING A ALPHITORRE WITH 2 AND 4 LEVELS (EVEN) OF FRAMES

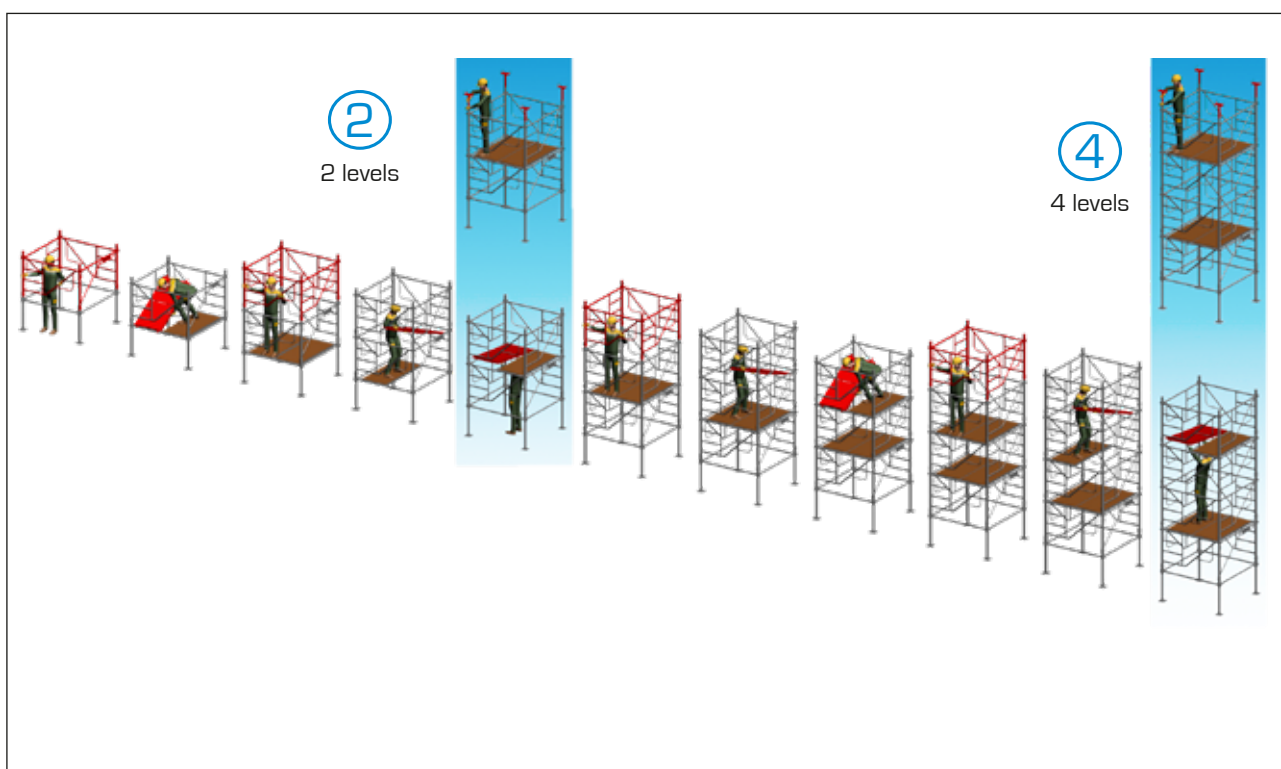

USER GUIDE: ASSEMBLING A 1.50 X 1.00 M TOWER

1



- Location and levelling.

2



- From the inside of the tower, install the 1st entrance frame in the diagonal axis and then rotate to lock

3



- Install the 1.50 m entrance frame to facilitate access.

4



- Install two 1 m planks with trapdoor and assemble the 2nd level.

USER GUIDE: ASSEMBLING A 1.50 X 1.00 M TOWER

5



- Assemble one floor level in temporary position.
- Install a 1st 1-m plank with trapdoor.

6



- Access to the upper level and then installation of the 2nd 1 m plank with trapdoor.

7



- Assemble the 3rd level.

8



- Reinstall the planks with trapdoor in their final position to obtain 2.00m between floor levels.
- Moving the 1st plank with trapdoor.

9



- Move the 2nd plank with trapdoor from the lower level.

10



- The first floor level can be removed. Access to the upper level via the built-in ladder.

11



- Set up and adjust the head jacks.

COMPOSITION CHART

	Number of frame levels	1	2	3	4	5
	Minimum height [m]	1.82*	2.37	3.37	4.37	5.37
	Maximum height [m]	2.46	3.46	4.46	5.46	6.46
Tower 1.50 x 1.00 m	Base jack	4	4	4	4	4
	1.50 m connector	2	2	2	2	2
	1.00 m connector	2	2	2	2	2
	1.50 m entrance frame	1	1	1	1	1
	1.50 m frame	1	3	5	7	9
	1.00 m frame	2	4	6	8	10
	2-inlet head jack	4	4	4	4	4
	1.00 m trapdoor plank with trapdoor	0/2	2	2**	4	4
	Weight [kg]	130/150	200	250	310	360

* Minimum height determined by the length of the two jacks

** Allow two additional floor planks with trapdoor for assembly

USER GUIDE: ASSEMBLING A 1.00 X 1.00 M TOWER

1



- Location and levelling. Install the 1st level frames with an entrance frame.

2



- Set up three 0.30 m planks and then install the 2nd level frames.

3



- Assemble the floor level in temporary position.
- Set up a 0.30 m plank and then access the upper level via the built-in ladder. Add two 0.30 m planks.

4



- Install the 3rd level frames.

5



- Raise the floor level to its final position to obtain 2.00 m between floor levels.
- Remove two 0.30 m planks and go down to the lower level, then remove the 3rd plank.

6



- Mount a 0.20 m plank and a plank with trapdoor.

7

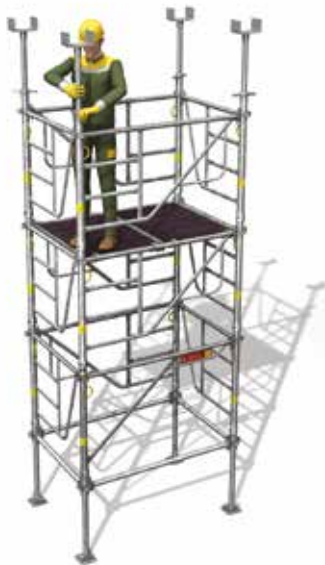

- The 1st floor level can be removed. Access the upper level and then set up and adjust the head jacks.

COMPOSITION CHART

	Number of frame levels	1	2	3	4	5
	Minimum height (m)	1.82*	2.37	3.37	4.37	5.37
	Maximum height (m)	2.46	3.46	4.46	5.46	6.46
Tower 1.00 x 1.00 m	Base jack	4	4	4	4	4
	1.00 m connector	4	4	4	4	4
	1.00 m entrance frame	1	1	1	1	1
	1.00 m frame	3	7	11	15	19
	2-inlet head jack	4	4	4	4	4
	1.00 m trapdoor plank with trapdoor	0	1	1	2	2
	Floor plank 0.20 x 1.0	0	1	1	2	2
	Floor plank 0.30 x 1.00	0/3	0	0**	0**	0**
	Weight (kg)	130/140	190	230	290	330

* Minimum height determined by the length of the two jacks

** Allow for three additional 0.30 x 1.00 m planks for assembly of towers starting from 3-levels

USER GUIDE: 6-BASE TOWER ASSEMBLY



- Location and levelling. From the inside of the tower, install the 1st entrance frame in the diagonal axis and then rotate to lock.



- Assemble the 2nd level.



- Assemble one floor level in temporary position.
- Install a 2nd plank.



- Crossbracing is essential with a connector and a diagonal brace.

USER GUIDE: 6-BASE TOWER ASSEMBLY

5



- Access the upper level and then install the 4th plank with trapdoor.

6

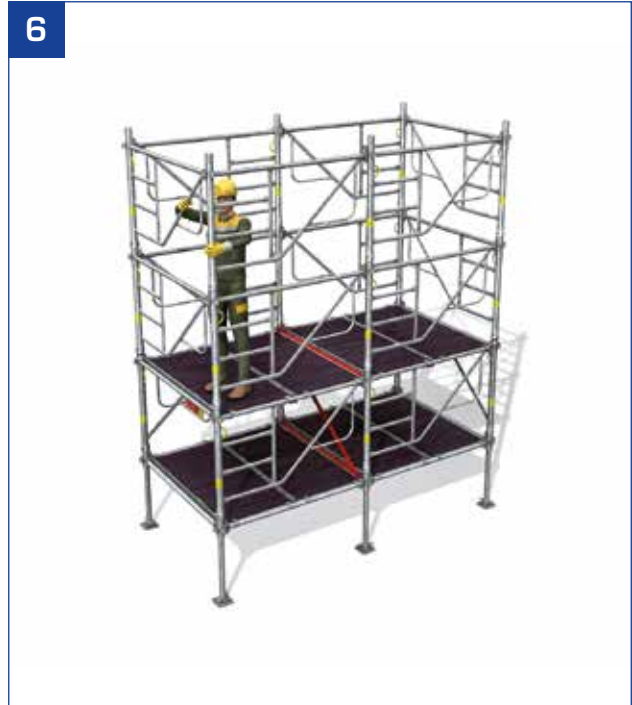

- Mount the 3rd level frames.

7



- Reinstall the planks with trapdoor in their final position to obtain 2.00 m between floor levels.
- Move the first 2 planks with trapdoor.

8



- Reinstall the planks with trapdoor in their final position to obtain 2.00 m between floor levels.
- Crossbracing is essential with a connector and a diagonal brace.

USER GUIDE: 6-BASE TOWER ASSEMBLY

9



- Move the 4th plank with trapdoor from the lower level.

10



- The first floor level can be removed. Access to the upper level via the built-in ladder.

11



- Set up and adjust the head jacks. Crossbracing is essential with a connector and a diagonal brace.

12

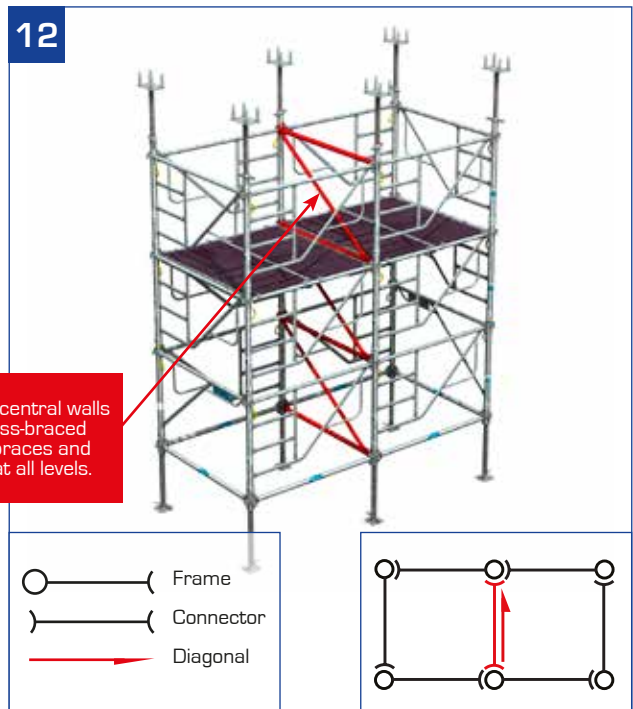

- Finish setting up and adjusting the 2 head jacks.

GIRDER LINKING

SOLUTION WITH CLINCH-FIT GUARDRAIL

The 1 m and 1.50 m clinch-fit guardrails protect workers during specific girder linking operations.

Advantages:

- Simple and quick.
- The guardrail is curved to allow girders to pass through.
- Allows towers to be moved.

Note: To link the girders, decking must be set up at top of the tower.



1 - Passage under the girders: 4 clinch-fit guardrails in low position.



2 - Install the 4 clinch-fit guardrails from the outside of the tower (tower height ≤ 2 frames).



3 - Safe assembly and disassembly from a floor level in temporary position (tower height ≥ 3 frames).



4 - Girder installation: clinch-fit guardrails in high position.



5 - Node formwork: option to lower the clinch-fit guardrails on the girder side.

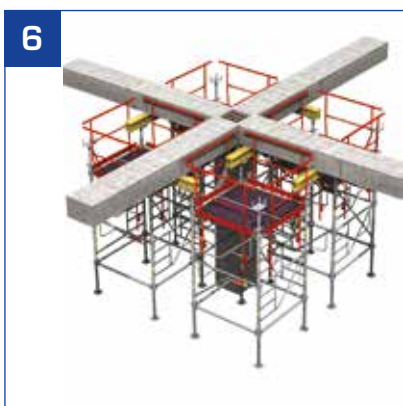

6 - Linking principle for 4 girders.

Moving



- Crane lifting: allow 4 additional slings to facilitate hooking from the floor.



- Or shifting with trolleys.

GIRDER LINKING

MOBILE GIRDER LINKING SOLUTION

AlphaTorre 1.50 m mobile scaffolding is equipped with a modular shoring extension in a 1.00 m module that is lifted in order to be moved.

Variable extension height:

- Option to create a half-level in the lower part of the mobile tower and the extension, with the single 0.50 m posts and the diagonal braces.

Note: To link the girders, decking must be set up at top of the tower.

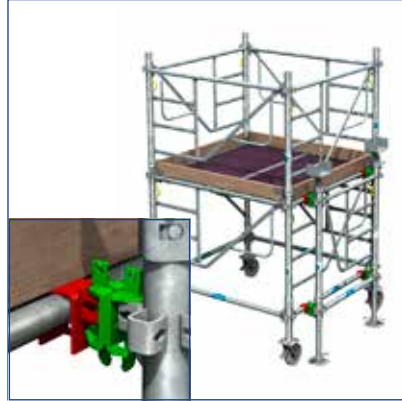

Extension secured using the "1-clamp U-bracket" and the "0.15 connector".



Variable extension height

Number of levels	2	3	4	5	
Number of extension levels	1	2	3	4	
Height with 2-inlet head jack (m)	min	1.82*	2.72	3.72	4.72
	max	2.30	3.30	4.30	5.30

*Minimum height determined by the length of the two jacks.

** If the 2-inlet head jack is replaced by the T1 MT65 head jack, the minimum height is then equal to 1.74 m [1.94 max].

BRACKET GIRDER LINKING SOLUTION

Decking at the top of the tower is easy and safe to create with the 0.38 m brackets.

1



- The decking is assembled with collective safety from a floor level in a temporary position.

2



- Installation of brackets, risers, connectors, 0.30 m planks and baseboards.

3



- Reinstall the planks with trapdoors. The operator must use a fall prevention system until the concrete beams have been installed.

4



ERGONOMICS

SHIFTING

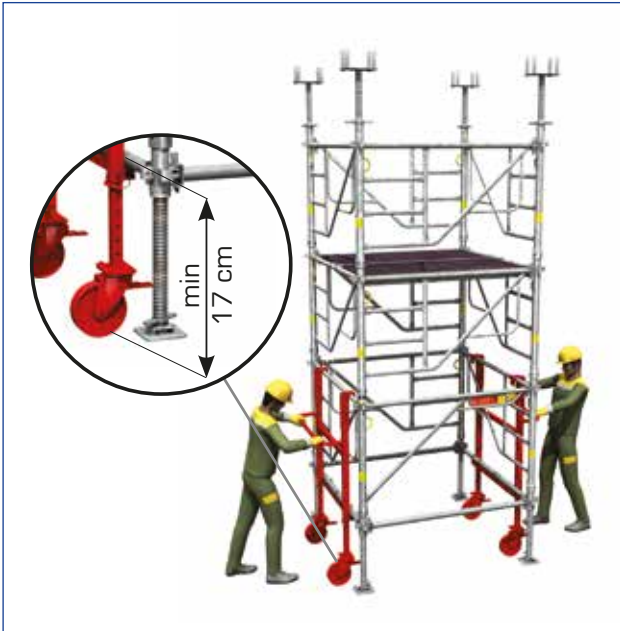

- On a concrete slab, the towers are easy to move, with their special trolleys.
- Do not shift a tower taller than three frames (four frames with the shifting trolleys with jack).

LIFTING

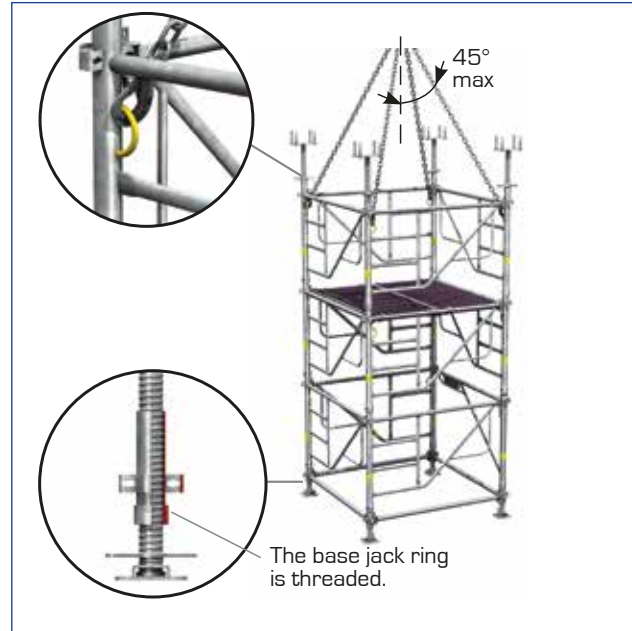

- The possibility of lifting with a crane is provided via built-in hoisting rings. This operation is facilitated and secured by the automatic locking of the tower elements, including the base jack.

ACCESS

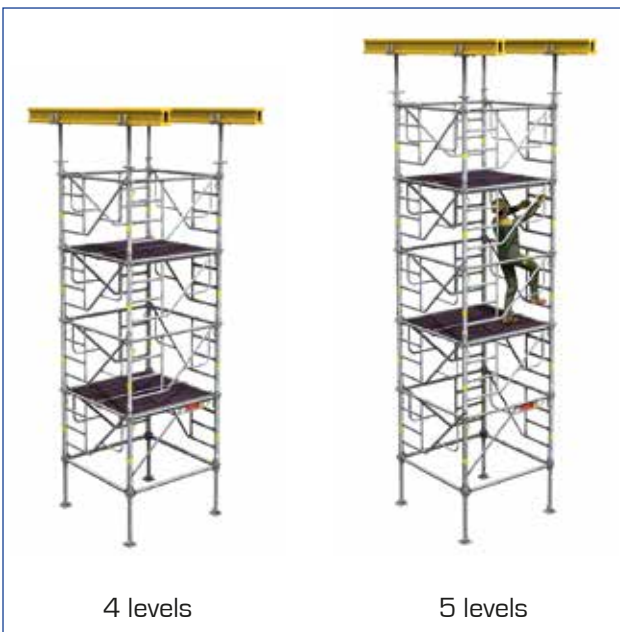

- The two planks with trapdoor are placed every 2.00 m for a "scaffolding" type access.

STORAGE



- The frames are packaged vertically, ready to be assembled to avoid having to bend down to straighten them.

Note: AlphaTorre was specially designed to limit repetitive strain injury. The weight of the most common parts is less than 15 kg and they are ergonomic to handle. Their design makes them easy to lift with a crane in order to limit disassembly and reassembly.

ERGONOMICS

HANDLING



- The AlphiTorre frame is installed from the inside of the tower, with just one interlocking point.

INSTALLING A PLANK



- To facilitate installation, hold the end with the right hand and forearm. Start by placing both hooks under the ladder.



- Lower the plank, leaning on the frame.

RAISE THE PLANK



- Two handles have been specially added under the plank to facilitate this operation.

Note: AlphiTorre was specially designed to limit repetitive strain injury. The weight of the most common parts is less than 15 kg and they are ergonomic to handle. Their design makes them easy to lift with a crane in order to limit disassembly and reassembly.

TECHNOLOGY AND STRENGTH

The allowable vertical load is 6 tonnes per post for a tower height below 6 m. Beyond that height, a special strength and stability calculation must be performed.

TECHNICAL CHARACTERISTICS OF MAIN PARTS

Description	Geometry	fy (MPa)
Frame: - Riser - Cross-piece	Tube Ø60.3 - thickness 2.7 Tube Ø40 - thickness 2	320 235
Connector	Tube Ø48.3 - thickness 2.7	320
Base jack	Tube Ø48 - thickness 5.6 threaded	320
Head jack	Tube Ø48 - thickness 5.6 threaded	320
Diagonal	Tube Ø38 - thickness 2.7	320

STABILITY

Due to wind, technical stabilisation measures must be applied, particularly during assembly and disassembly. For normal wind conditions, it is advised to limit the height of the light tower hoist to 3.5 times the smallest side of the base (three times for mobile equipment). Beyond that, towers should not be isolated, but connected to each other or the existing structure in order to stabilise them in all directions.

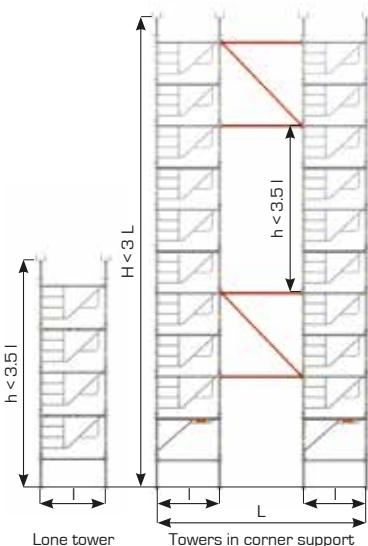

FUNCTIONAL DIMENSIONS

Standard AlphaTorre with 2-inlet head jacks and base jacks

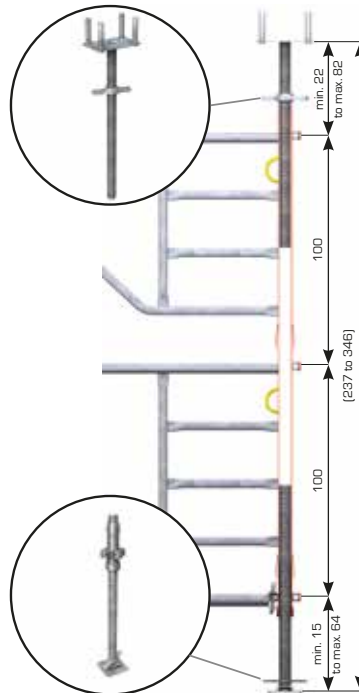

With a single frame level:

- Variable height: 1.82 to 2.46 m.
- The minimum height is determined by the length of the two jacks.

LOW ALPHITORRE

Standard AlphaTorre with T1 Tower head jacks and base jacks

- Variable height: 1.40 to 2.09 m.

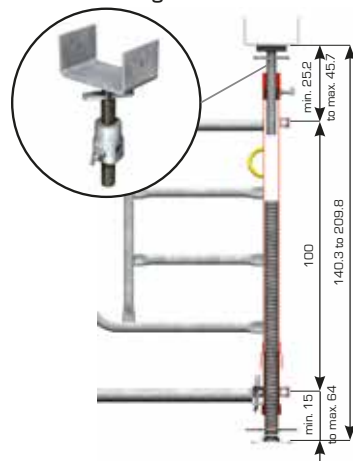

Standard AlphaTorre with 2-inlet head jacks and stud-free bases

- Variable height: 1.46 to 2.06 m.

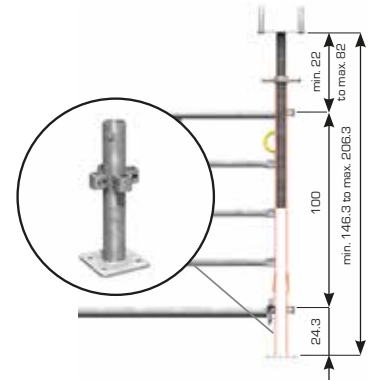

AlphaTorre with 2-inlet head jacks and stud-free bases

Tower consisting of single 0.50 m posts and diagonal braces.

- Variable height: 0.96 to 1.56 m.

CAUTION: The single posts must be cross-braced by diagonal braces and connectors at all levels.

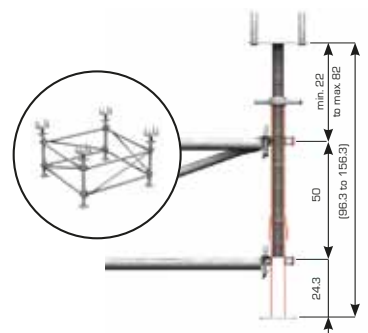

AlphaTorre with T1 Tower head jacks and stud-free bases

- Variable height: 0.49 to 0.70 m.

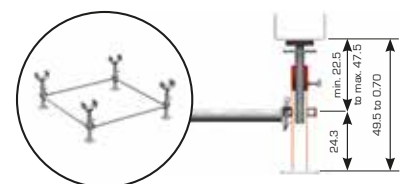

COMPATIBLE WITH SCAFFOLDING SYSTEMS

FLOOR PLANKS BETWEEN TOWERS

From a height of 3.00 m, decking between towers is essential for formwork and formwork removal operations.

It is easy to create using connectors and planks. An entrance frame can be added at the top of towers to access the decking.

Distribution

Description	Mesh width (cm)						Bracket (cm)	
	70	100	150	200	250	300	38	100
25 cm plank	-	-	2	4	-	2	-	-
30 cm plank	2	3	3	3	8	8	1	3

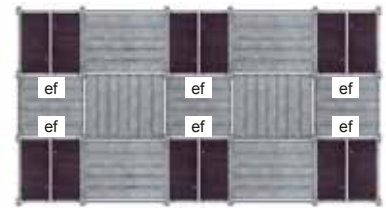
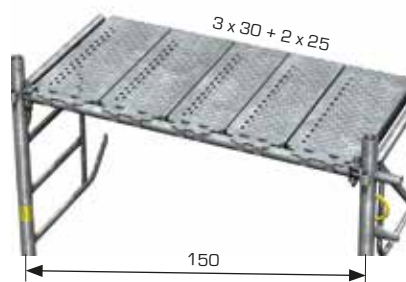

ef: Entrance frame to access decking
The direction of the planks should be alternated if possible so as not to overload the connectors.

MDS guardrail between towers

The MDS guardrail can be used to secure the edge of the decking between each tower.



Plank for formwork and formwork removal operations

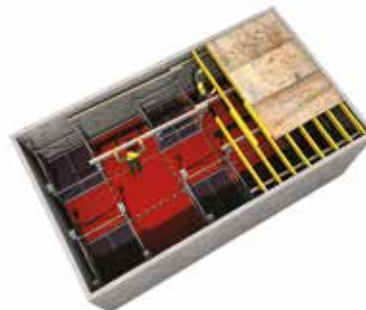

Choice of load-bearing connector for a 200 kg/m² load distributed on the floor planks

Load-bearing connector	Plank length				
	100	150	200	250	300
70	C	C	C	C	C
100	C	C	C	C	C
150	C	C	C	C	C
200	C	C	C	RC	RC
250	C	RC	RC	RC	RC
300	RC	RC	RC	RC	RC

C: connector / **RC**: reinforced connector

ASSEMBLY KINEMATICS FOR DECKING BETWEEN TOWERS

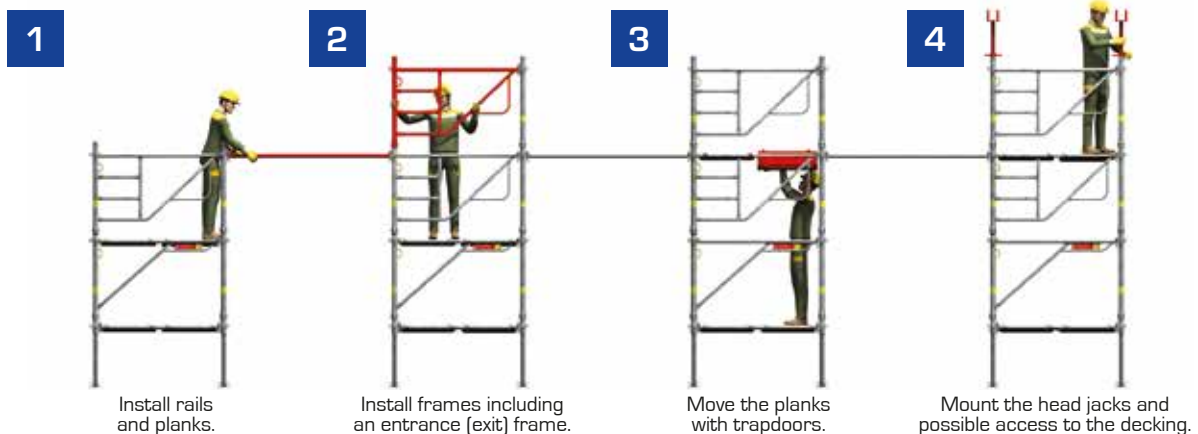

In the absence of a wall around the perimeter of the decking, envisage installing MDS guardrails.

COMPATIBLE WITH SCAFFOLDING SYSTEMS

AlphiTorre allows you to assemble connected towers to create block and row configurations, without tubes or collars. Each 1.00 m high post must be cross-braced and secured at both ends, in both directions.

With respect to the connector, the diagonal brace is mounted on the side on which the plank is parallel with these components so as to prevent interference between the plank hooks and the diagonal brace.

CAUTION: The central walls must be cross-braced by diagonal braces and connectors at all levels.

6-BASE TOWERS

6-base tower component layout rules:

- At the edge and on the 1st level: 2 entrance frames, preferring the 1.50 m mesh.
- On the inside and at all levels: 1 diagonal brace and 1 connector.

9-BASE TOWERS

9-base tower component layout rules:

- At the edge and on the 1st level: 2 entrance frames, preferring the 1.50 m mesh.
- On the inside and at all levels: 1 standard frame, 3 diagonal braces and 3 connectors.

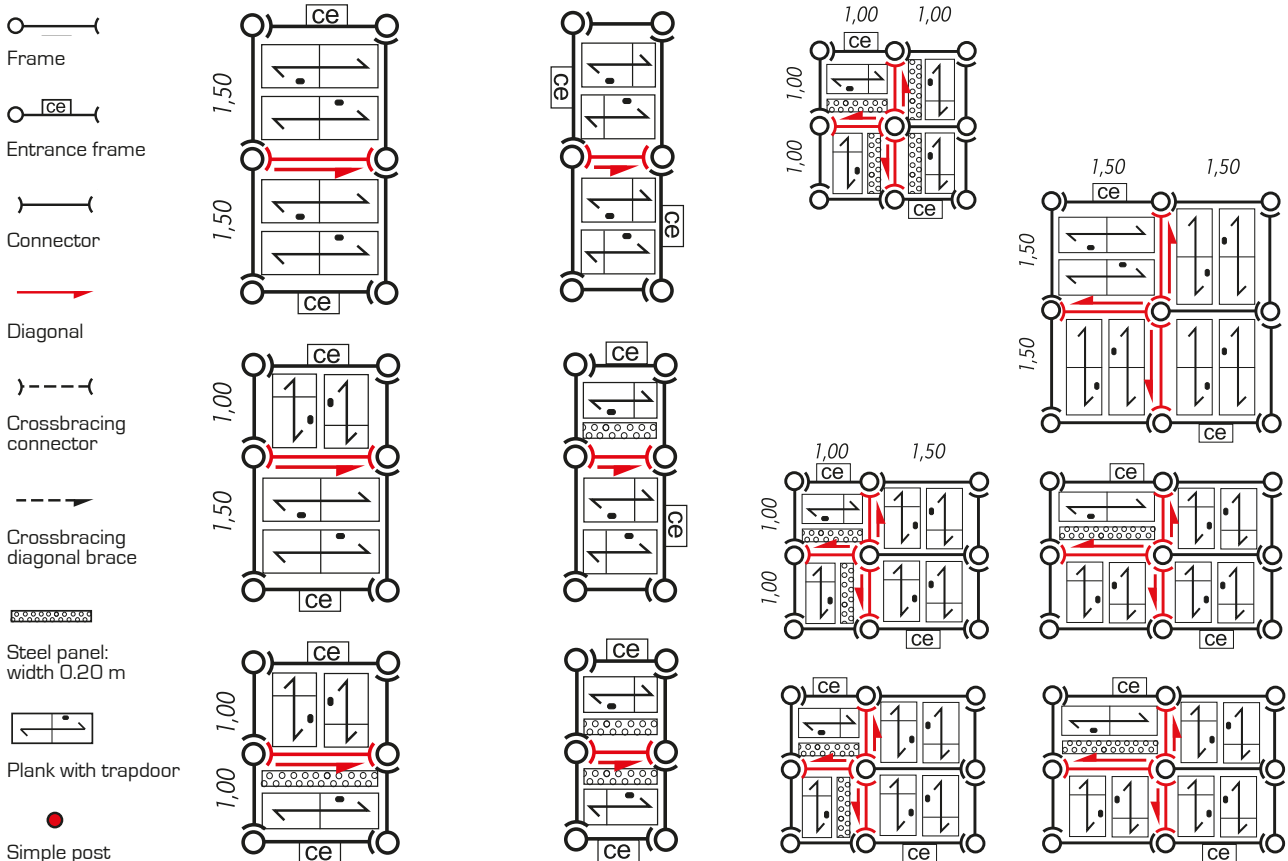
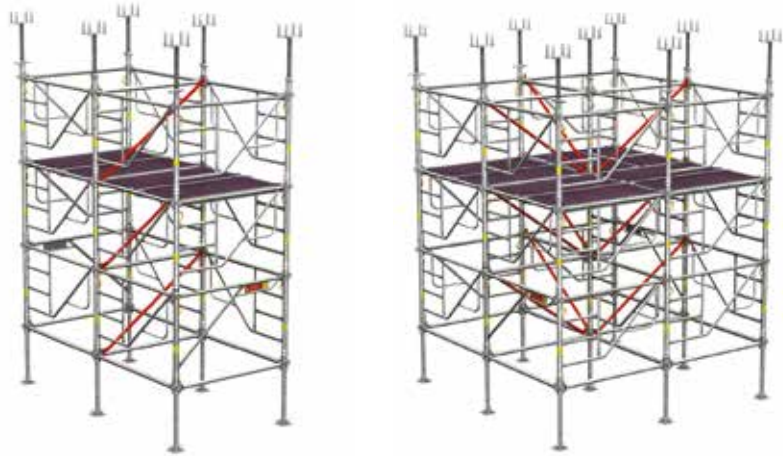

COMPATIBLE WITH SCAFFOLDING SYSTEMS

CROSSBRACING

Crossbracing and connections between towers are added very simply with our connectors and our scaffolding diagonal braces, avoiding the complicated use of tubes and collars. If the towers are equipped with decking at the top, the crossbracing should be positioned at least 1.00 m below the plank to prevent interference with the diagonal braces.

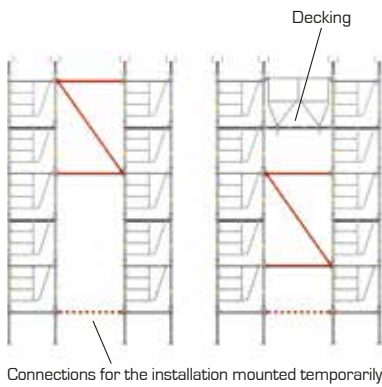

TOWERS WITH EXTENSION

An extension is created using frames and single posts, for example:

- In practice, it is advised to limit the number of cross-braced posts to 4, for one frame, on one level.
- The 0.15 m connector is not suitable for extensions.

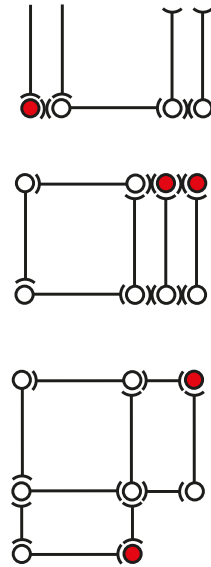

BLOCKS

Connected towers

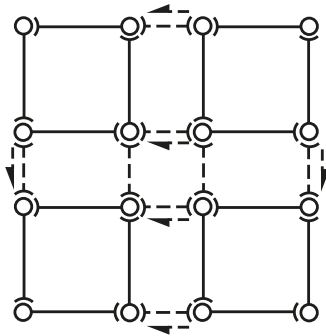

or

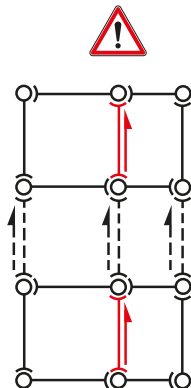

ROW

Row with crossbracing between towers

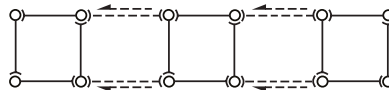
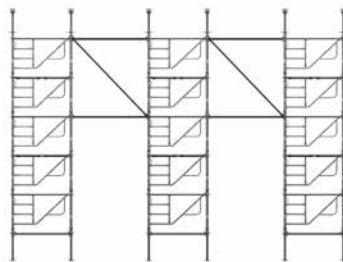

Continuous row

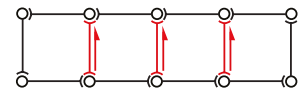

Same principle as a 6-base tower.

Row with extensions

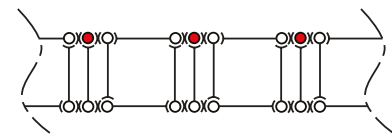

HEIGHT DIFFERENCE WITH SINGLE POSTS

Shoring systems can be created with a height difference at the head or base, using single 0.50 m or 1.00 m posts with diagonal crossbracing.

Height difference at head

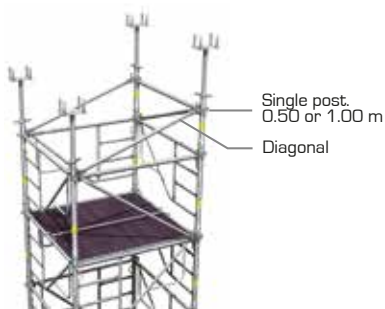

Height difference at base

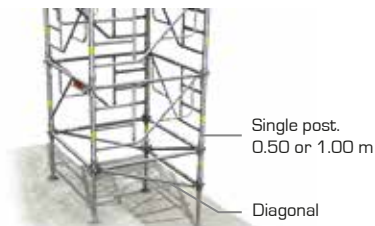

Height difference between 2 towers



CAUTION: The single posts must be cross-braced by diagonal braces and connectors at all levels.

ALPHITORRE MOBILE SCAFFOLDING

The "AlphiTorre wheel" transforms your shoring tower into mobile scaffolding with a very stable "square" base.

Advantages

AlphiTorre mobile scaffolding retains the inherent advantages of the AlphiTorre shoring tower:

- **safety feature:** automatic locking, built-in lifting ring, built-in access ladder,
- **limited number of parts,**
- **easy assembly,**
- **can be lifted with a crane.**

CAUTION: 200 kg max on mobile equipment = workers with tools.



COMPATIBLE WITH SCAFFOLDING SYSTEMS

BRACKETS

The AlphiTorre base lets you create a bracket.

The allowable load F at the end of the bracket is limited to 500 daN. For higher loads, a case study is required.

The load applied to the bracket is supported by the load-bearing post.

A properly designed tethering or crossbracing system must ensure the stability of the tower.

Assembly of the bracket and the last level of the tower from the lower level (frame + single post)

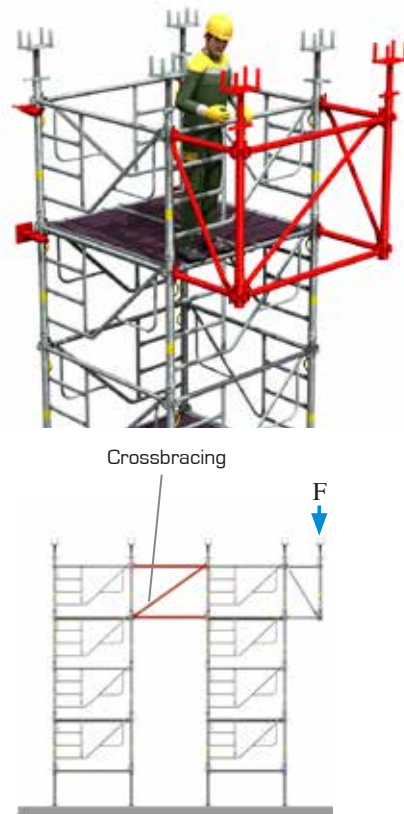
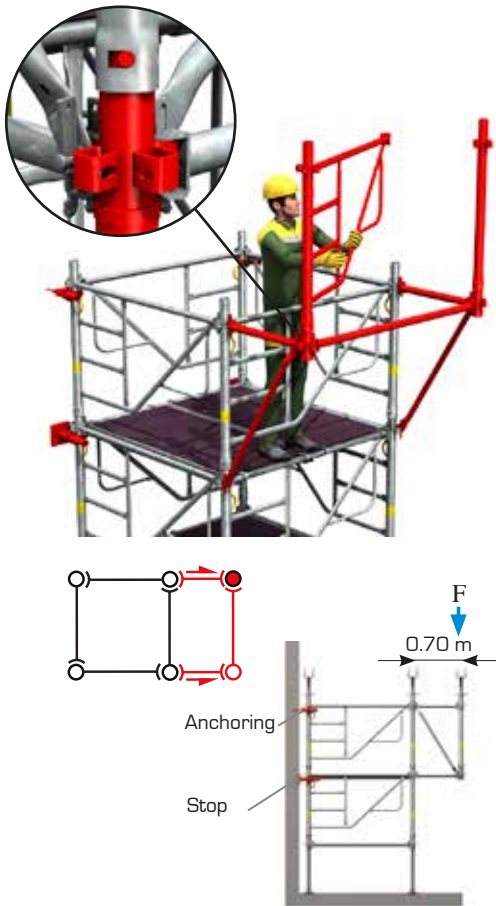

Addition of a bracket to a pre-assembled tower from the last level (2 single posts + connectors and diagonal braces)

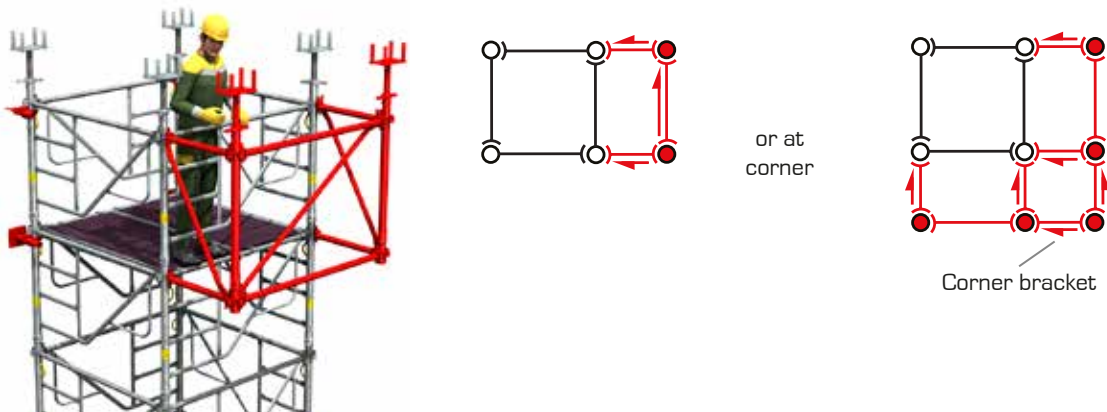

SPECIAL CASES

MOBILE TOOL FOR GIRDER FORMWORK

Several tools are positioned side-by-side under the girder.

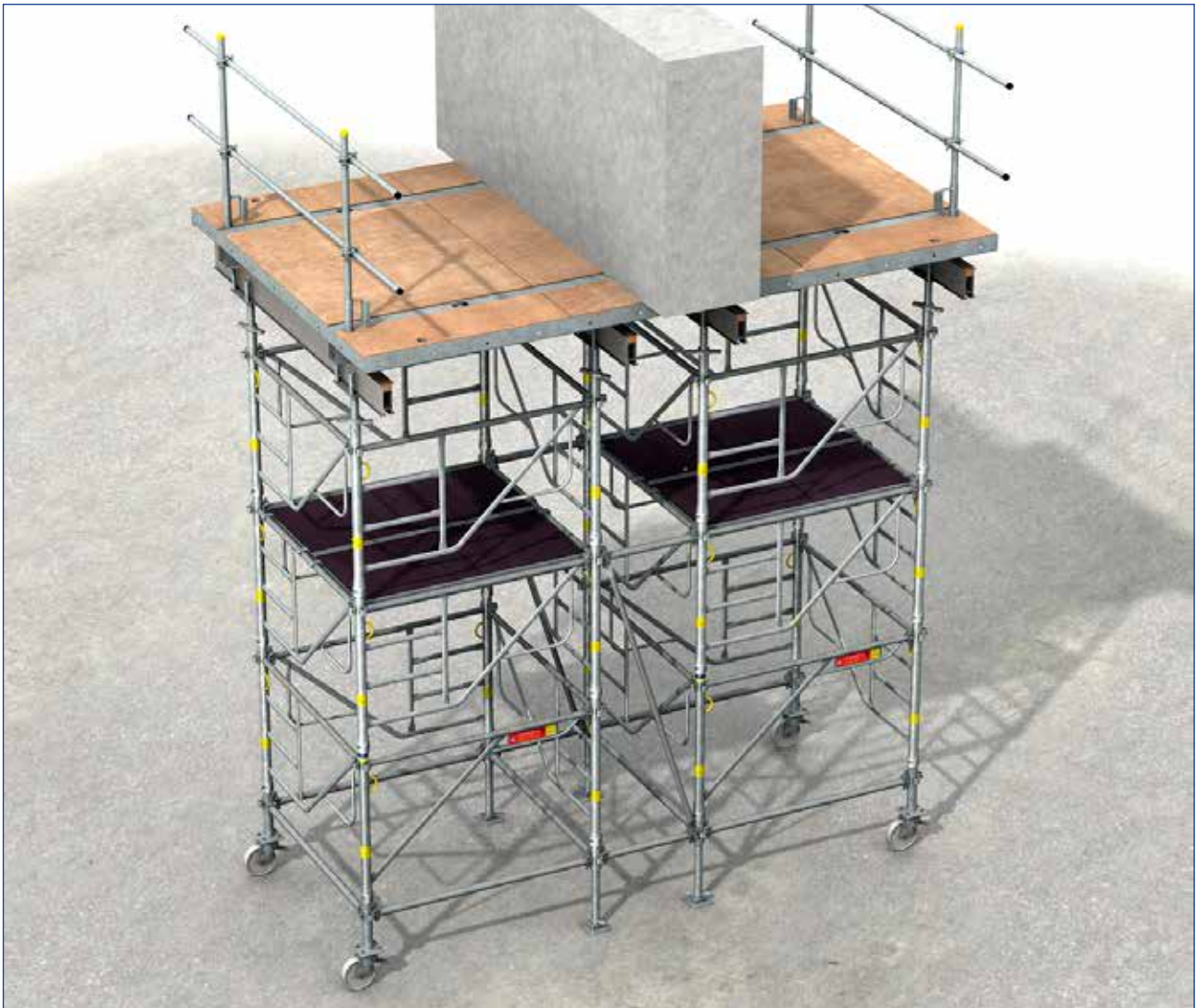

In shoring position:

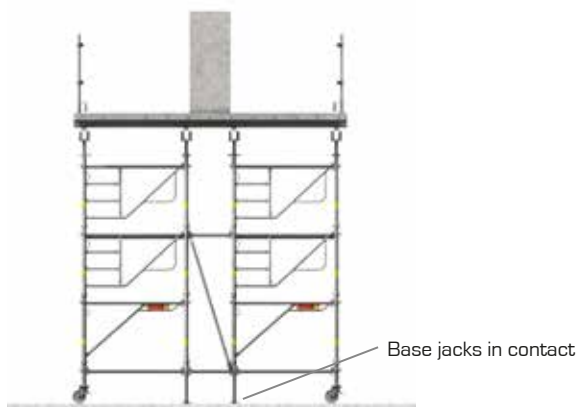

In shifting position:

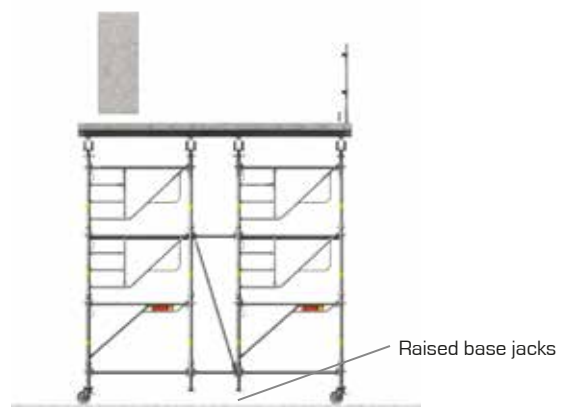

ALPHI, THE FRENCH SHORING SPECIALIST



The AlphiTorre shoring tower with built-in safety features is quick and easy to use. It can be adapted to all possible configurations. Ergonomic, it offers a proper work surface for worker safety.

Savoie Hexapole, Actipole 5 - 242, rue Maurice Herzog
73420 Viviers-du-Lac
FRANÇA

Tel.: 0033 4 79 61 85 90 - Fax: 0033 4 79 61 85 99 - info@alphi.fr

Gabinete de estudos: Tel.: 0033 4 79 61 85 91 - be@alphi.fr

Serviço logístico: Tel.: 0033 4 79 61 85 92

Alphi
Formwork and solutions

Designed in France 

www.alphi.fr